

Owner's Manual

INCLUDES

User, Maintenance, Service, and Installation
Instructions



780 FL



Keep this booklet for service log and future reference

IMPORTANT



This appliance is guaranteed for 12 months subject to conditions. The 5 year extended parts warranty will only be valid if the annual service recommended in this manual has been completed and appliance has been registered online.

Contents

EXTENDED FIVE YEAR PARTS WARRANTY	2
Benchmark Scheme	3
SECTION ONE Introduction (user instructions)	5
SECTION TWO Operating the Appliance (user instructions).....	7
SECTION THREE Cleaning (user instruction)	10
SECTION FOUR Fuel Bed Cleaning and Layout (user instructions).....	11
SECTION FIVE General Points (user instructions)	14
SECTION SIX Appliance Data (installation instructions).....	15
SECTION SEVEN Regulations and Warnings (installation instructions).....	16
SECTION EIGHT Siting the Appliance (installation instructions).....	17
SECTION NINE To Install the Appliance (installation instructions).....	19
SECTION TEN Checking Operation of Fire (installation instructions).....	21
SECTION ELEVEN Maintenance (maintenance instructions).....	22
SECTION TWELVE Wiring Diagram (maintenance instructions).....	24
GAS FIRE COMMISSIONING CHECKLIST.....	26
SERVICE RECORD.....	27



EXTENDED FIVE YEAR PARTS WARRANTY

In order to validate your extended 5 years parts warranty please read the Benchmark Scheme on the opposite page and ensure your installer has filled in the appropriate checklist.

This in no way reduces your statutory rights

Your warranty commences from the date of purchase and you must retain your receipt or invoice as proof of a purchase date.

THIS EXTENDED WARRANTY SPECIFICALLY EXCLUDES GLASS AND SOFT REFRACTORY COMPONENTS, THE BULB AND ANY BATTERIES.

Terms and Conditions

1. The appliance must be installed by a GAS SAFE registered person.
2. The appliance must be used in accordance with the user's instructions.
3. The appliance must be serviced annually by a GAS SAFE registered person.
4. The benchmark and service log must be correctly filled out and the record of annual services must be up to date and supported by receipts in each case.
5. This warranty is not transferable and relates to the original installation only.
6. The appliance has not been subjected to misuse or accident or been modified or repaired by any person other than the authorised employee or authorised representative of Charlton and Jenrick Ltd.
7. The registration form must be returned within 1 month of purchase.

Technical Help Desk 01952 200 444

Benchmark Scheme



Charlton and Jenrick Ltd is a licensed member of the Benchmark Scheme which aims to improve the standards of installation and commissioning of domestic heating and hot water systems in the UK and to encourage regular servicing to optimise safety, efficiency and performance. Benchmark is managed and promoted by the Heating and Hotwater Industry Council. For more information and the full code of practice please visit www.centralheating.co.uk

Please ensure that the installer has fully completed the Benchmark Checklist on the inside back pages of the installation instructions supplied with the product and that you have signed it to say that you have received a full and clear explanation of its operation. The installer is legally required to complete a commissioning checklist as a means of complying with the appropriate Building Regulations (England and Wales).

All installations must be notified to Local Area Building Control either directly or through a Competent Persons Scheme. A Building Regulations Compliance Certificate will then be issued to the customer who should, on receipt, write the Notification Number on the Benchmark Checklist.

This product should be serviced regularly to optimise its safety, efficiency and performance. The service engineer should complete the relevant Service Record on the Benchmark Checklist after each service.

The Benchmark Checklist will be required in the event of any warranty.

It is a requirement that the gas fire is installed and commissioned to the manufacturer's instructions and the data fields on the commissioning checklist completed in full.

To instigate the guarantee, the gas fire needs to be registered with the manufacturer within one month of the installation.

To maintain the guarantee, it is essential that the gas fire is serviced annually by a Gas Safe registered engineer. The service details should be recorded on the Benchmark Service Interval Record and left with the householder.

Important

For future reference we suggest you record the following details here, and keep the receipt as proof of purchase. This information may be asked for when you contact the helpdesk.

MODEL:	INFINITY 780 FL	Serial No.	
---------------	------------------------	-------------------	--

This information can be found on the label attached to the packaging and on the data badge, which is located on the base of the appliance behind the control cover.

Retailer Name:	
Address:	
Date Of Purchase:	

Installer information required to register for the extended warranty

Name:	
Date of installation:	
Gas safe number:	

SECTION ONE Introduction (user instructions)

Consumer protection information

As manufacturers and suppliers of heating products, we take every care, as far as is reasonably practicable, that these products are designed and constructed as to meet the general safety requirement when properly used and installed. To this end, our products are thoroughly tested and examined before despatch.

IMPORTANT NOTICE: Any alteration that is not approved by the appliance manufacturer could invalidate the approval of the appliance, operation of the warranty and could affect your statutory rights.

Health and safety notice

Important

This appliance could contain some of the materials, indicated below, that could be interpreted as being injurious to health and safety. It is the users / installers responsibility to ensure that the necessary personal protective clothing is worn when handling these materials, see below for information.

Artificial Fuels, Mineral Wool, Insulation Material, Refractory/Ceramic Fibres, Glass Yarn - *may be harmful if inhaled, may be irritating to skin, eyes, nose and throat.*

When handling, *avoid inhaling and contact with skin or eyes. Use disposable gloves, facemasks and eye protection. After handling wash hands and other exposed parts. If a vacuum is used for cleaning the coals or cleaning after servicing / installation it is recommended that it be of the type fitted with a HEPA filter.*

Disposal of refractory/ceramic materials. To keep dust to a minimum these materials should be securely wrapped in polythene and be clearly labelled 'RCF waste'. These materials are not classified as 'hazardous waste and should be disposed of at a site licensed for the disposal of industrial waste.

INTRODUCTION

- The 780 FL as been designed and tested to the requirements of EN 613 and is suitable for use in GB (Great Britain) and IE (Ireland).
- The 780 FL incorporates a single gas control, which selects ignition pilot, with variable setting between low and high settings and is operated via remote control. The system is powered by a battery pack; therefore no mains electrical supply is required.
- Like all appliances incorporating an aerated burner a low frequency noise may be heard, this may be more noticeable on the low setting.
- The 780 FL incorporates a safety device in the form of an Oxygen Depletion System, which constantly monitors the oxygen in the room and will cause the fire to switch off if the oxygen level reduces, for instance due to insufficient ventilation or a blocked flue.
- If this regularly occurs do not attempt to relight the appliance until a qualified engineer has checked it, the problem may not be due to lack of air or a defective flue.
- The pilot can be left on (standby setting) or the pilot can be extinguished and relit each time the fire is used.

The 780 FL is battery operated; therefore no mains electrical supply is required. Power to the appliance is provided by 6 high power alkaline 1.5V batteries (C size) (a spare set of 6 C batteries is supplied with the appliance).



If you hear a repeated 'bleep' sound come from the appliance this indicates the appliance battery pack is low and should be changed. If this is ignored the system will go into a lock out mode, which will not allow the appliance to be used until a new set of batteries are loaded. (See Page 6)

IMPORTANT INFORMATION





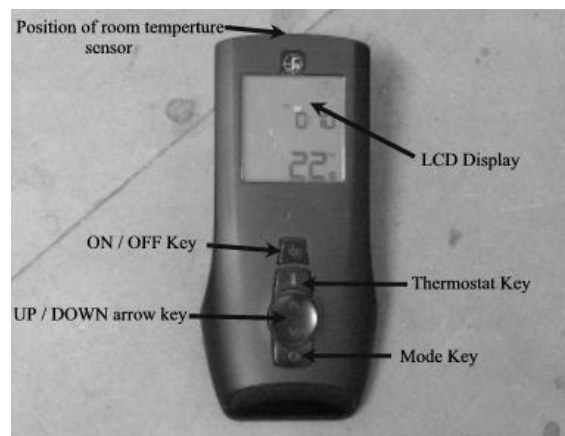

- The appliance is for use on Natural Gas (G20 @ 20mbar) or L.P.G. (G31 @ 37mbar) only.
- The chimney or flue (unless new or previously used with a gas appliance) shall be swept before installation if it has been used for solid fuel.
- Failure to install appliance correctly could lead to prosecution.
- In GB (Great Britain), the appliance must be installed by a competent person i.e. GAS SAFE-registered, in accordance with the GAS SAFETY (INSTALLATION AND USE) REGULATIONS, The Building Regulations (or The Building Regulations (Scotland) or The Building Regulations (Northern Ireland)) and The Current I.E.E. Wiring Regulations, if appropriate.
- In IE (Ireland), the appliance must be installed by a competent person and installed in accordance with the current edition of I.S.813 Domestic Gas Installation, the current Building Regulations and the current ETCI rules for electrical installation, if appropriate.
- The glass front of this fire acts as a dress guard, conforming to BS 1945 (1997) however; a fireguard conforming to BS6539 (1997) must be used to protect young children, the elderly or infirm.
- The appliance **MUST NOT** be used with the glass safety screen removed or if it is damaged or cracked.
- During initial firing, an odour may be evident. This is the starch binder used during the manufacture of the fibre components of the fire, and there are **no harmful** effects produced.
- During the normal operation of the fire some black staining may appear on some parts of the fuel bed. This is quite normal and adds to the appearance of the appliance. However, if excessive black staining does occur it may be due to the fuel bed being incorrectly laid. This should be checked prior to contacting a service engineer.
- When using black glass liners care should be taken to ensure flames do not make contact with them as this will result in staining or permanent marking.
- Care must be taken to prevent any damage being caused to surrounding soft furnishing or decoration; e.g. many embossed vinyl wall coverings may become discoloured if placed too close to the appliance. Combustible material i.e. wall panelling or wallpaper must be removed from behind the fire and fire trim.
- It is advised that this appliance is serviced annually as recommended by Gas Safe. This is more likely to provide trouble-free operation and is a requirement of the extended parts warranty.(see page 20)
- In GB (Great Britain) the fire does not normally require purpose built ventilation, but if for any special reason purpose built ventilation is provided it should be checked periodically to ensure freedom from obstructions.
- In IE (Ireland) permanent ventilation must comply with the current edition of IS813.

SECTION TWO Operating the Appliance (user instructions)

To light the appliance using the remote hand set:

- A. Press the  button. Continue to hold the button for approximately 2 seconds and release. When released a beep should be heard and the appliance will automatically go through the ignition sequence and the pilot should ignite. Once the pilot is alight the appliance will automatically go to the high setting (approximately 20-25sec).
- B. If the ignitor stops sparking and the pilot has failed to light press the  button for at least 2 seconds and release again a beep should be heard. Then repeat the lighting procedure. * See note on page 9



- A. With the appliance lit, by pressing  key the operational mode is switched from manual to Room Thermostat setting and vice versa. When Room Thermostat mode is active, the display shows the set temperature value and the "AUTO" icon will appear on the LCD display. By using the  arrow key the desired room temperature can be set. When manual mode is active, the display shows the "MAN" icon plus the flame icon and a five level bar icon setting. By pressing the  arrow key, the flame picture can be adjusted at five stages between high and low flame. If level 5 is currently active, the icon max  below the flame icon will appear. *Note: Due to the nature of the gas, flame variation on LPG models will only be visible on Hi and Lo setting*
- B. To switch off the appliance press the  button for at least 2 seconds and on releasing the button the appliance will beep and then shut off. For pilot setting press the  button for 1 second and release. The pilot symbol will appear on the LCD display. Pressing the  will bring the fire back on to main flame.
- C. The appliance can be switch off with out using the hand set by removing the appliance batteries located below the air grill cover. When the batteries are removed there will be a delay (up 3minutes) after which double bleeps may be heard and shortly after the appliance will extinguish. Ensure that the battery is reconnected once the fire as been extinguished. The appliance cannot be operated without the use of the handset.

Room Thermostat mode

The remote handset checks the room temperature at a fixed time intervals. Depending on the difference between set room temperature and the actual room temperature the remote proceeds to modulate in one level steps. Once the room temperature is reached it moves to standby position pilot only. The icon "PILOT" will appear on the LCD display. As soon as the actual room temperature falls below the SET room temperature, the system will move from standby to the high flame level. From this point it will proceed again the modulation process.



Note: Due to the temperature checks at timed intervals, the display temperature on the handset may exceed the room setting temperature before the appliance defaults to the pilot setting.

To Replace Battery In Hand Set (3 AAA type batteries)

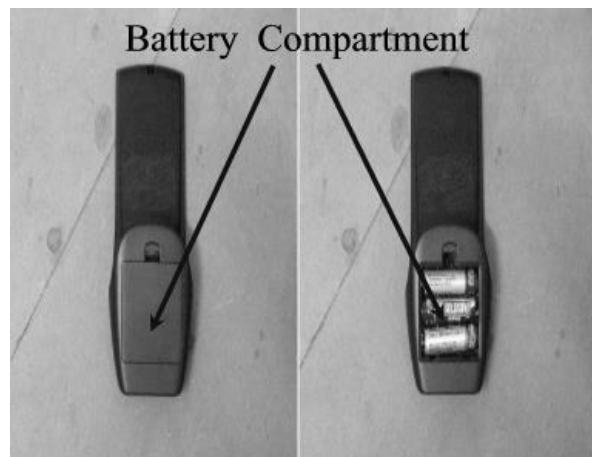
Remove the cover from the rear of the handset and fit replacement battery.





Clock Regulation

As soon as the batteries are fitted the timer digits will blink. Using the  arrow key increase or decrease the hour, minutes and week's value. Pressing the  will set and shift setting until complete.



Note: This time setting is for guidance only and does not have a guaranteed accuracy level.

Changing Clock Setting During Operation To amend clock setting press both the  and  keys simultaneously for three seconds, the written clock will appear. To change the clock settings, repeat the above described operation.



Change From Celsius to Fahrenheit With remote OFF, keeping pressed  key at least for 5 seconds, the temperature unit changes from Celsius to Fahrenheit degrees and vice versa.



Battery level indication (Handset)



When the batteries have to be changed in the handset, the related icon will appear.



Setting the sleep mode

To activate the sleep mode: With the fire switched on press the  button. The sleep symbol  will appear top right.

The sleep symbol replaces the time indicator in this mode. Using the  arrow key increase the sleep mode in 15 minute intervals (a small star will be visible next to the sleep symbol once any time is set) . Once the set time is reached, the fire will completely switch off without any further intervention.

When the fire is next operated, the sleep mode will automatically appear unless it is re-set to zero. This can be done by pressing the  key and using the  button to decrease the time set by 15 minute intervals until back to zero.

If you experience unexplained outing on the fire please check that the sleep mode is switched off.

Child Lock (Handset)

To activate `Child Lock` : Press and hold the Mode Key **O** button for 5 seconds, this will lock and disable the handset and a “padlock” symbol will appear on the bottom of the screen. This can be done while the fire is “off” or “on”. To deactivate this function press and hold the Mode Key **O** for 5 seconds and the “padlock” symbol will disappear.

LOW BATTERY INDICATION (APPLIANCE)

If you hear a repeated ‘bleep’ sound come from the appliance this indicates the appliance battery pack is low and should be changed. If this is ignored the system will go into a lock out mode, which will not allow the appliance to be use until a new set of batteries are loaded.

NOTE: The appliance cannot be used when the battery is completely discharged.

TO REPLACE APPLIANCE BATTERIES (6 High Power Alkaline C 1.5V)

- A. Remove the fireplace frame covers which are held in place with magnets.
- B. Lift out the air grill cover from the bottom of the frame assembly.
- C. The battery power pack holder is located in a compartment at the left hand side of the burner. Carefully lift the battery holder out of the compartment and replace the six high power alkaline C batteries as a complete set. **WARNING, batteries will overheat if fitted incorrectly, when fitting the batteries ensure that they are fitted as per the marking on the rear of the holder (i.e. minus of battery against spring).**
- D. Once the new batteries are loaded the fire will continue to bleep until re-set. Press the ON / OFF key for at least 2 seconds, on release a bleep sound be heard and the ignition process will start. If the fire continues to bleep this may indicate a loose connection or badly loaded batteries.

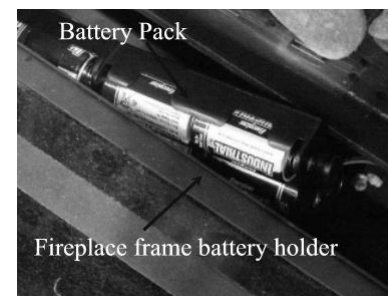
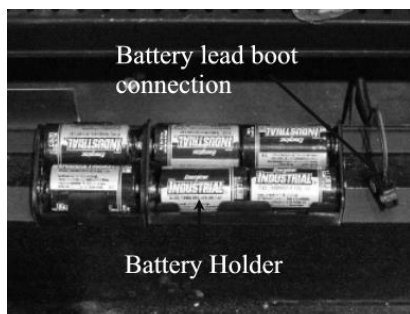

***Important :** If the fire burner or pilot is extinguished for any reason, do not attempt to re-light the pilot for at least 3 minutes.

SECTION THREE Cleaning (user instruction)

Warning: -

Before you clean any part of the appliance ensure that the appliance is turned off and cold.

CLEANING: PILOT ASSEMBLY

(Before cleaning ensure that the appliance is turned off and cold)

In some instances you may experience ignition problems even when the appliance is new. This may be due to the aeration hole in the pilot body being partial blocked with dust, pet hairs, or other foreign matter. The source of this debris could be such things as carpet fibres, decorating or pet etc.

To gain access to the pilot, please do the following.

- Remove the two side covers LH and RH.
- Undo the two M4 nuts retaining the glass fixing bracket using the tool provided then pull clear and from the location studs.
- Carefully lift the glass panel from within the bottom location slot.
- Remove the log fuel bed shapes and bark shapes.
- Lift out the air tray assembly from the location points within the shelf.

The pilot is located on the right hand side of the appliance, any debris in or around the aeration hole should be removed using the nozzle of a vacuum cleaner. It is advisable not to blow the debris into the hole as this may cause more of a restriction and not rectify the problem.

Note: - Take care when cleaning in this area so as not to damage the pilot assembly.

REMOVING GLASS PANEL

- Remove the two side covers LH and RH which are held on with magnets.
- Undo the two M4 nuts retaining the glass fixing bracket using the tool provided then pull clear from location studs.
- Carefully lift the glass panel from within the bottom location slot.

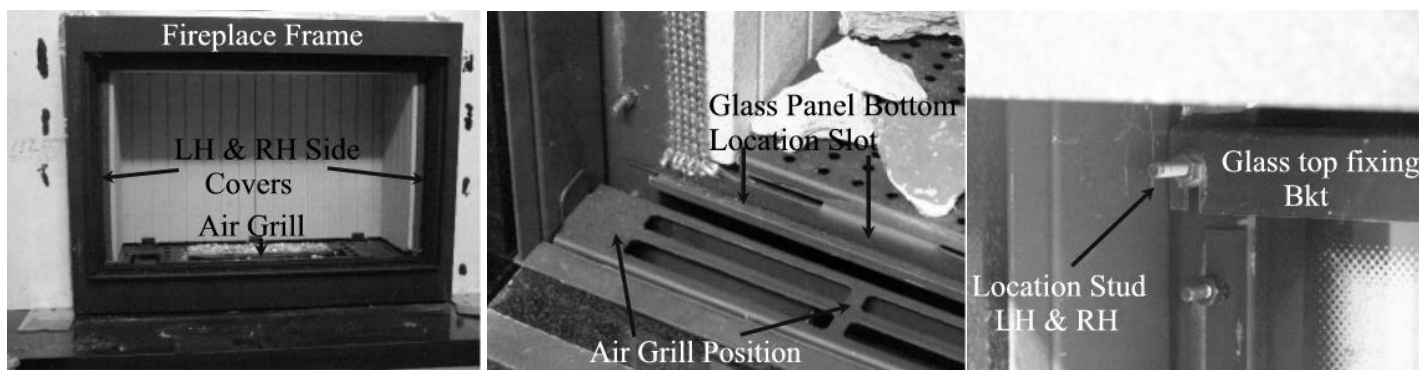

GLASS CLEANING

From time to time it will be necessary to clean the glass panel of your 780 FL. We recommend you use a Ceramic hob cleaner these are available for all leading super markets: - i.e. ASDA, TESCO, SAINSBURY'S Etc.

Brands of hob cleaning we have tested and found suitable are - **HOB BRITE & VITRO CLEAN.**

- Ensure the fire has been turned OFF for at least four hours to ensure it is cool.
- Remove the glass panel as described below.
- Lay the glass panel down on a flat working surface on top of an old opened newspaper with the side to be cleaned uppermost.
- Follow the instructions on the Hob Cleaner Bottle.
- On stubborn stains (where the appliance has been used for a long period without glass panel being cleaned), use a new Brillo Pad well wetted with the Hob cleaner applied directly to it.
- Ensure all the residues of the cleaner are removed with a damp cloth and the glass panel is completely dry before fitting to the appliance.

Important:- The appliance must not be used if the glass panel is missing or damaged.

Note: - The glass may discolour quickly when first installed, and it should be cleaned. This is due to the burning off process of the refractory fuel bed shapes.

SECTION FOUR Fuel Bed Cleaning and Layout (user instructions)

- Before you clean any part of the appliance ensures that the appliance is turned off and cold.
- Use only the fuel bed components provided and no additional parts must be added.
- Incorrect positioning of the fuel bed components could result in the staining of the glass panel.

Important: - Refer to the 'Health & Safety Notice located on page 3 of this booklet before cleaning or replacing any refractory material.

- The fuel bed components are delicate and they should be handled with great care.
- The moulded shapes may be removed for cleaning. They can be brushed very gently with a soft brush to remove dust or any deposits.
- A vacuum cleaner may only be used after the loose components and moulded shapes have been removed.

CARE SHOULD BE TAKEN TO AVOID CONTACT WITH THE REFRACTORY LINING THIS IS A DELICATE SURFACE AND SHOULD **NOT BE WIPED OR RUBBED.**

It is important that all the fuel bed moulded shapes are positioned as shown in these instructions.

Fitting the fire liners

Once the firebox is secured into position fit either the vermiculite or brick back liners supplied.

Position the 2- piece rear liner behind the 3 lugs located at the bottom rear of the firebox. The vermiculite liner has a vertical joint and the brick back has a horizontal joint. Ensure these are aligned centrally.

Rest the side liner against the firebox on either left or right hand side. Push up the securing bracket to hold liner in position. The vermiculite liners are reversible but the brick back liners will only fit one way.

Once liners are in place fit the air-tray and lay fuel bed.

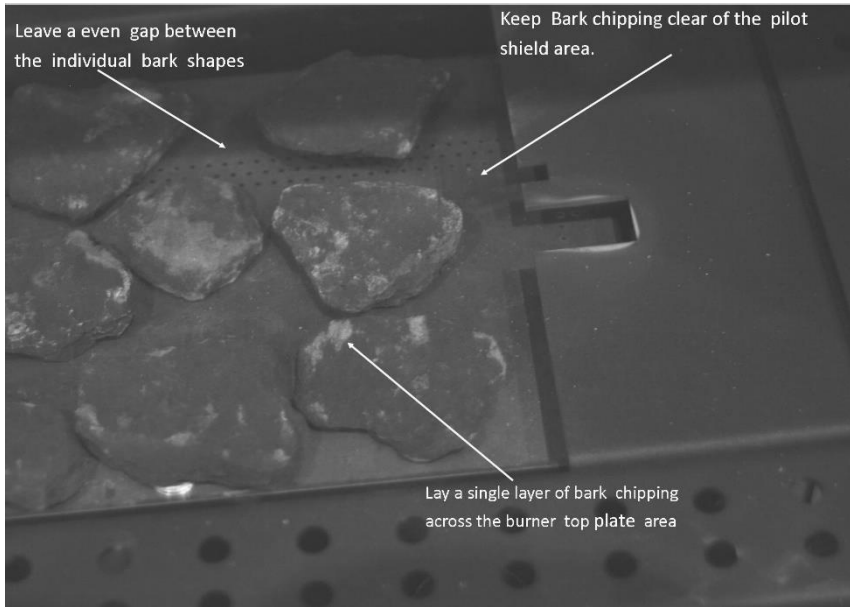

- Please make sure no loose shapes are placed directly on top of the pilot shield. (Please see figure above.)

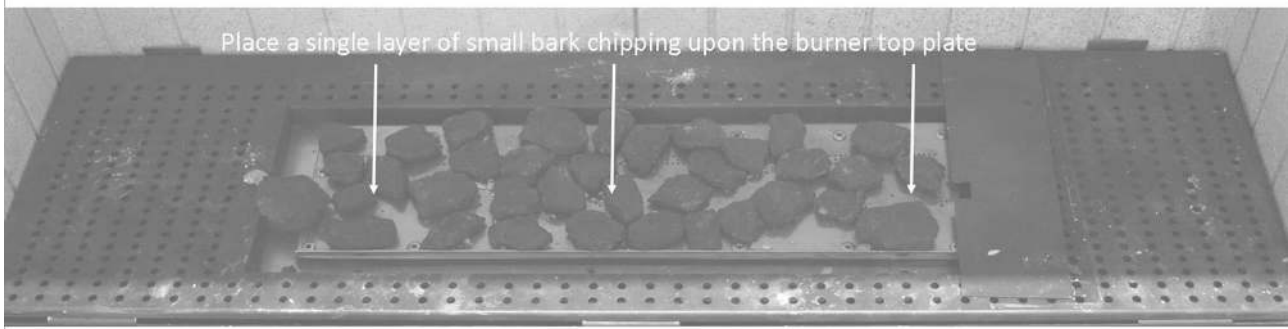

- Place the small bark shapes as shown above. (Please note that vermiculite will be provided on LPG models).

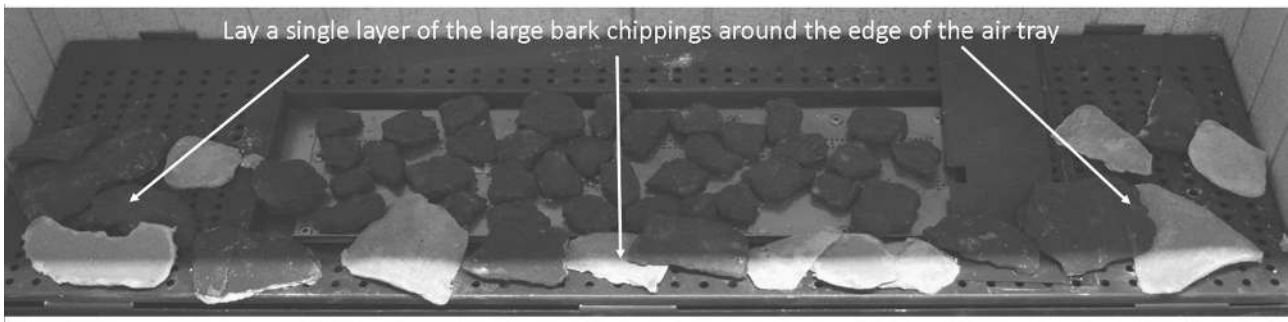

- Place the bark shapes around the edge of the air tray as shown above.

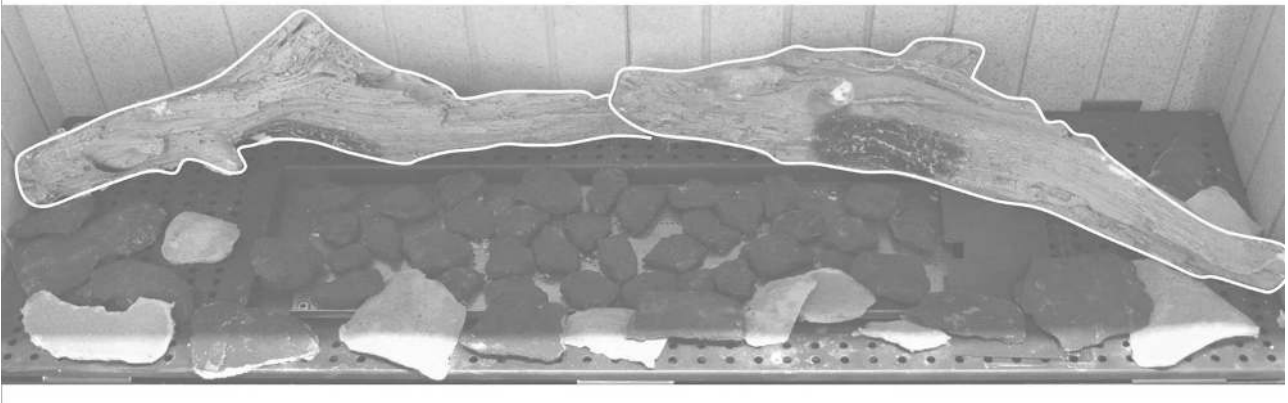

- Place the 2 log shapes as shown above.

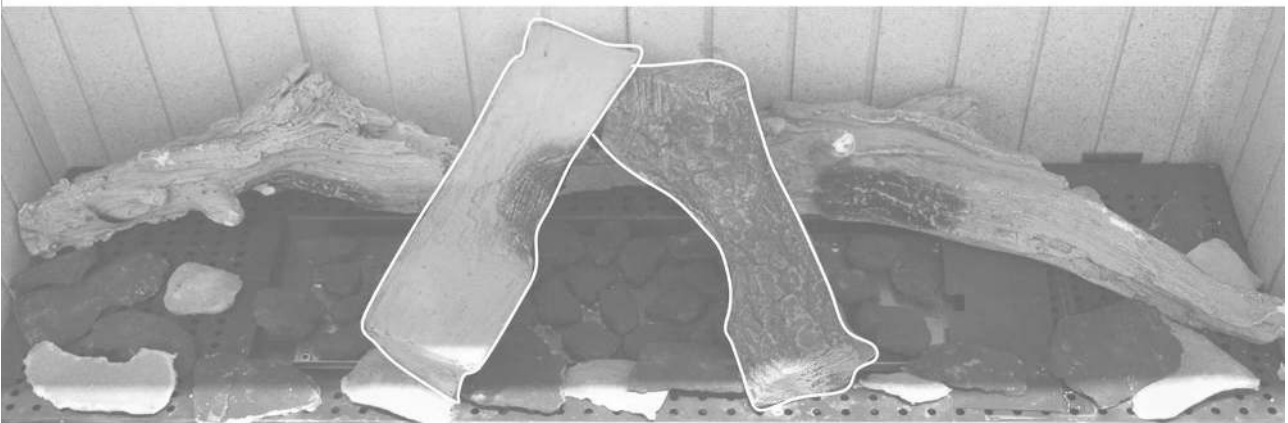

- Place the 2 log shapes as shown above.



- Place the 2 log shape as shown above.

SECTION FIVE General Points (user instructions)

Like all appliances incorporating an aerated burner a low frequency noise may be heard, particularly on the low setting, this is quite normal and does not affect the operation of the appliance.

It is advised that a competent person service the 780 FL fire annually. The fire is more likely to provide trouble-free operation.

Dulling and slight discoloration inside the firebox will occur adding to the realism of the appliance. This is normal.

It is important that: -

The chimney or flue is checked annually to ensure clearance of combustion products. This can be inspected by removing the inner firebox and removal of the inspection covers located on the back and top of the outer firebox. This can be obtained by doing the following.

- Remove side covers and glass (refer to section 3)
- Remove the log fuel bed shapes.
- Lift out the air tray assembly from the location points within the shelf.
- Pull out the air grill and disconnect the battery holder from the lead and remove.
- Remove the two screw retaining the gas connection cover from within the burner shelf and remove cover. Shut down restrictor elbow and disconnect the 8mm inlet nut.
- Undo the three fixing screws from the burner tray and lift out burner tray assembly taking care not to damage the liners.
- Remove the six M4 nuts from the front face of the inner firebox.
- Taking care not to damage the top liner remove the two fixing screw from the top of the inner firebox.
- Carefully pull the inner firebox forward to clear the outer firebox assembly.
- Remove the inspection plates located within the outer firebox taking care not to damage the sealing gaskets.
- After inspection for clearance is completed, reassemble in reverse order.

The only user removable parts are: -

- Refractory Fire bed Components
- Side covers and air grill.
- Glass panel top fixing bracket.
- Glass panel.

NOTE: During operation some sooting will be evident on the fuel bed whether running on the high or low setting. This may be reduced by running on the opposite setting for 15 minutes prior to switching the fire off i.e. If fire is running on high then turn to low for 15 minutes before turning off. This will not eliminate all soot but helps keep it to a minimum.

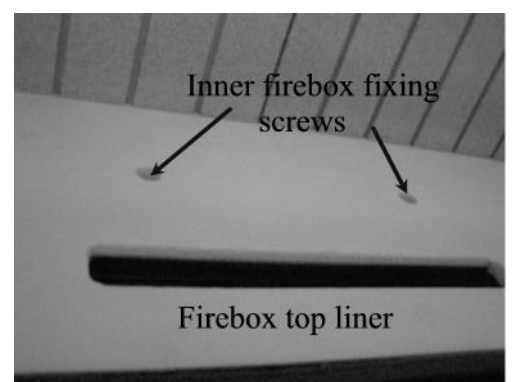

SECTION SIX Appliance Data (installation instructions)

NATURAL GAS

PROPANE GAS

Gas Type:.....	CATEGORY I 2 H	CATEGORY I 3 P
Gas Pressure:.....	20 mbar +/- 1.0mbar	37mbar +/- 1.0mbar
Pressure Test Point Location:.....	Gas inlet elbow	
Gas Input:.....	6.6 kW Gross (Max.)	7.0 kW Gross (Max.)
	2.4kW Gross (Min.)	2.4 kW Gross (Max.)
NOx Classification	5	
Injectors:.....	Mk 460 A	Mk 135
Oxy pilot:.....	9079 N.G.	9264 L.P.G.
Gas Connection:.....	8mm compression: semi-rigid or rigid	
Data Badge Location:....	Located on the right hand side of the appliance behind the trim and fascia.	
Battery Remote handset	3 x 1.5v AAA,	
Appliance	6 x 1.5V C high power alkaline.	

Appliance Dimension

NOTE: The efficiency of this appliance has been measured as specified in BS7977-1 2009+A1:2013 and the result is 72.71%. The gross calorific value of the fuel has been used for this efficiency calculation. Gastec have certified the test data from which it has been calculated. The efficiency value may be used in the UK Government's Standard Assessment Procedure (SAP) for energy rating of dwellings. **Please note:** Within the appliance packaging will be a outlet restrictor, this is there to achieve the maximum efficiency. This, however, may not be fitted due to the flue underperforming.

When unpacking the appliance please, check the following items are included:

Fuel Bed, Air Tray, Fireplace Frame Assembly.

Owner's Manual and Vermiculite (LPG only)

SECTION SEVEN Regulations and Warnings (installation instructions)

- This appliance must only be installed in Great Britain or Ireland.
- The appliance is suitable for use on natural gas only.
- **GB (Great Britain)** This fire does not normally require purpose built ventilation.
- **IE (Ireland)** Permanent ventilation must comply with the current edition of IS813.
- **In GB, (Great Britain)**

It is the law that all gas appliances must be installed by a competent person; i.e. a GAS SAFE registered installer, in accordance with the Current Gas Safety (Installation And Use) Regulations (as amended), all relevant parts of the local and national building regulations and all relevant recommendations of the following British Standards. Failure to do so could lead to prosecution.

The following are relevant codes of practice and British Standards: -

B.S. 5871

B.S. 5440 PART 1 & PART 2

B.S. 6891

This appliance must be installed to current versions of the above standards and include any relevant amendments to:-

The Building Regulations Issued By The Department Of The Environment.

The Building Standards (Scotland) (Consolidated) Regulations Issued By The Scottish Development Office.

- **IN IE, (Ireland)**

The appliance must be installed by a competent person and installed in accordance with the current edition of I.S.813 Domestic Gas Installation, the current building regulations, and the current ETCI rules for electrical installation, if appropriate.

- Prior to the installation ensure that the local distribution conditions (identification of type of gas and pressure) and adjustment of the appliance are compatible (G20 @ 20mbar) or (G31 @ 37mbar)

WARNINGS

- The glass front of the fire acts as a dress guard, conforming to BS 1945 (1971) and satisfies the heating appliance regulations (1991) However, a guard conforming to BS6539 (1984) must be used to protect young children, the elderly or infirm.
- **This appliance incorporates a safety device in the form of an Oxygen depletion system. IT MUST NOT BE ADJUSTED OR PUT OUT OF OPERATION! THIS IS A NON-SERVICABLE ITEM AND MUST BE EXCHANGED AS A COMPLETE ASSEMBLY; USING ONLY THE ORIGINAL MANUFACTURER'S PART.**
- A suitable proprietary fire surround with a 150°C minimum rating is required.
- During initial firing, an odour may be evident. This is the starch binder used during the manufacture of the fibre components of the fire, and there are **no harmful** effects produced.
- Care must be taken to prevent any damage being caused to surrounding soft furnishing or decoration; e.g. many embossed vinyl wall coverings may become discoloured if placed too close to the appliance.

SECTION EIGHT Siting the Appliance (installation instructions)

- **CLASS ONE**

That is a conventional brick or stone chimney as used for a solid fuel appliance with an effective cross-sectional dimension of 225 x 225 mm (9" x 9") or a lined flue with a minimum diameter of 125mm (5"). The chimney must have a minimum effective height of at least 3 metres. Any permanent flue restriction or variable dampers are to be removed or locked fully open. The chimney should be swept prior to installation if it has previously been used with solid fuel. This is not necessary if the flue has previously been used with a gas appliance or if it is a new installation.

Note: A brick or stone chimney with a 125 mm (5 ins) minimum diameter flue liner conforming to BS 715 may be used. Provided a suitable sealing plate is fitted to the base of the liner and the appliance does not restrict the opening into the liner. Ensure a smooth lead into the flue way and no combustible materials are used. A void of 50mm must be maintained from the top of the firebox to gather into flue.

PREPARING THE OPENING FOR STANDARD INSTALLATION

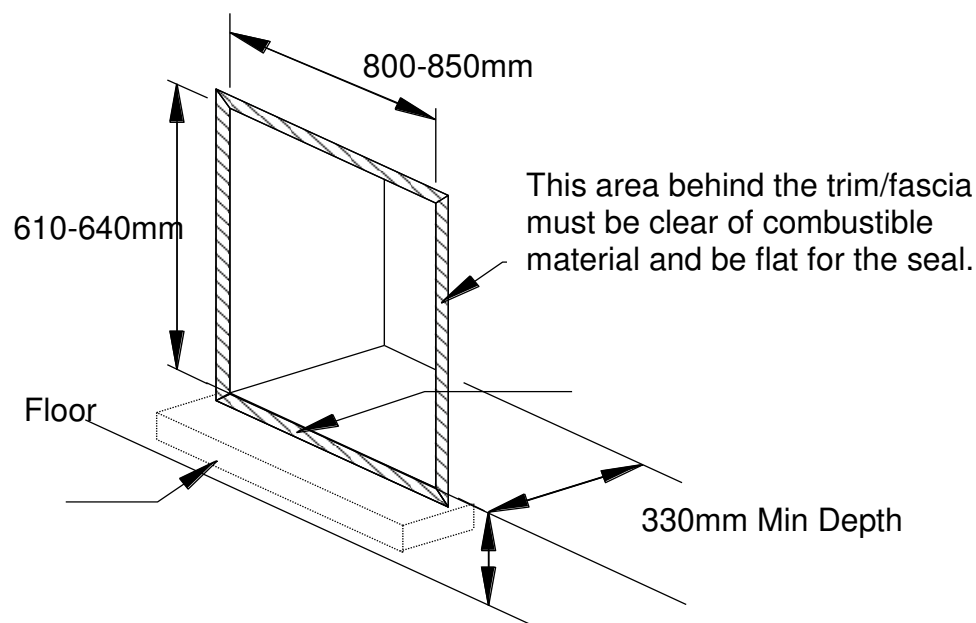

The front face and the base of the fire opening must be flat to ensure that a good seal is formed between the rear and base of the appliance and the chimney to avoid any reduction of natural draught.

*** Please note: It is important to ensure the bottom of the firebox is completely sealed to reduce the risk of excess sooting resulting from incomplete combustion.**

PREPARING THE OPENING FOR INSTALLATION WITH MARBLE SLIPS

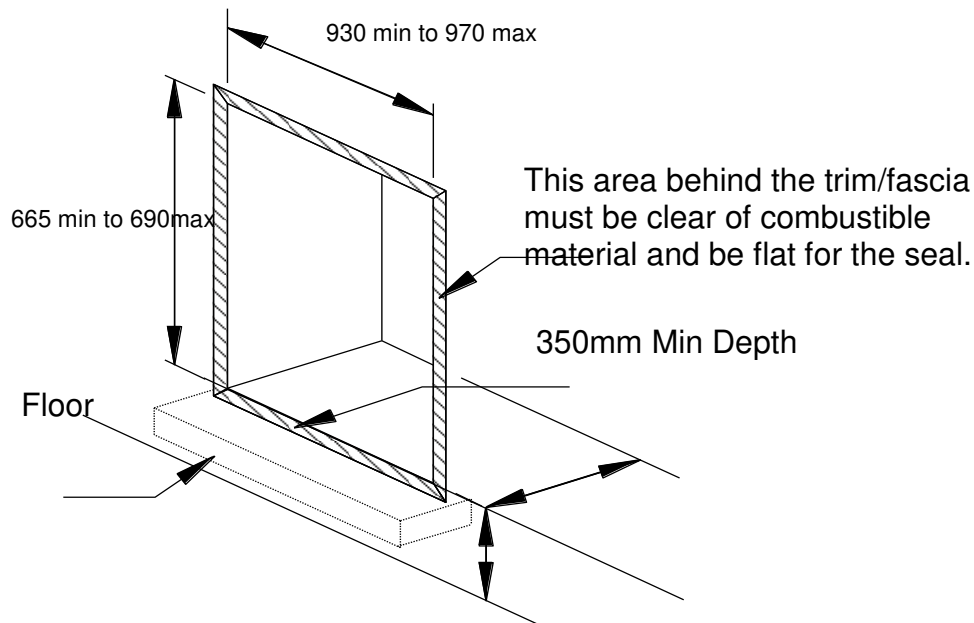

The front face and the base of the fire opening must be flat to ensure that a good seal is formed between the rear and base of the appliance and the chimney to avoid any reduction of natural draught. *** Please note: It is important to ensure the bottom of the firebox is completely sealed to reduce the risk of excess sooting resulting from incomplete combustion.**

Locate the slip mounting frame (supplied as an optional extra) by hooking onto the existing studs on the firebox with the fireplace frame already located. It is the responsibility of the installer to ensure the slips are secured using a reliable bonding material.

Class one Installation with a flexible liner using optional gather hood (Part No A-0293)

- Route the flexible liner within the brick built flue as of the requirements stipulated by the liner manufacture.
- Attach the gather hood to the liner using a suitable fixing at a height that clears the out fire box assembly.
- Remove the inner box and top inspection cover as described in section five general points.
- With the out fire box in place, attach the gather hood to the fire box using the four fixing screws provided within the kit.
- Re-assemble in reverse order.

Clearance to Shelf

Minimum clearance from hearth or base of opening to underside of combustible shelf should be 800mm provided the shelf depth is 75mm (3"). This gives a minimum clearance above the appliance of 140mm. For a shelf of 150mm (6") the minimum height above the hearth or base of opening must be 880mm. This will give a minimum clearance above the appliance of 220mm.

Clearance to Sides of Fire

Minimum width between vertical sides of combustible surround should not be less than 875 mm provided fire is central to the surround and sides do not project more than 150 mm. When vertical side forward projection is increased by 12.5 mm add 50 mm to inside width of surround.

CHECKING THE FLUE AND FIRE OPENING

- Check that the chimney conforms to the required specifications as previously stated. Examine the condition and carry out any remedial work including removing any debris from the base.
- If the flue has been used for solid fuel it should be swept prior to the installation
- Prior to installing the appliance a smoke test (using a smoke bomb) should be carried out to check that satisfactory smoke clearance has been established.

If all the smoke is not drawn into the flue, pre-heat the flue with a blowtorch or similar and re-check. If there is any uncertainty examine for the cause and, if necessary, seek expert advice.

No combustible material should be fitted inside the fireplace opening.

- When installing this appliance against a dry lined (plasterboard) wall ensure that any void between the plasterboard and the wall is sealed with a suitable non-combustible material (i.e. plaster or mortar).

SECTION NINE To Install the Appliance (installation instructions)

GAS SUPPLY ROUTING

Use rigid or semi – rigid tube to connect the supply. Determine the gas supply pipe route to the appliance before installing the fire.

Fixing Firebox Assembly

- Slide the firebox into the fireplace open guiding the gas supply pipe through the hole at the rear LH bottom of the firebox.
- Retain the Firebox using wall plugs and screw using the four holes within the firebox flange.
- Refit the grommet over the pipe and seal around the inlet hole.
- The Fireplace frame can now be located onto the firebox assembly and retained using the six off M4 nuts provided.
- Remove the gas connection cover located within the burner shelf left hand side and connect to the restrictor elbow provided.

Note: - The isolation valve must be fitted at a angle to allow access to the restrictor plug plus gas pressure test nipple.

- At this point the fireplace or false chimney breast front will need to be constructed.
- Connect battery pack as described in section 2. (Operating the appliance). Locate the battery pack in the holder positioned within the fireplace frame.
- Now check that a signal is being received by pointing the remote control hand set in the direction of the appliance and press ON / OFF Key for at least 2 seconds. On release a bleep should be heard and the ignition process will start.

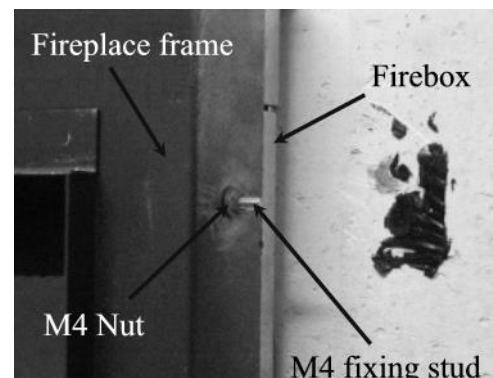
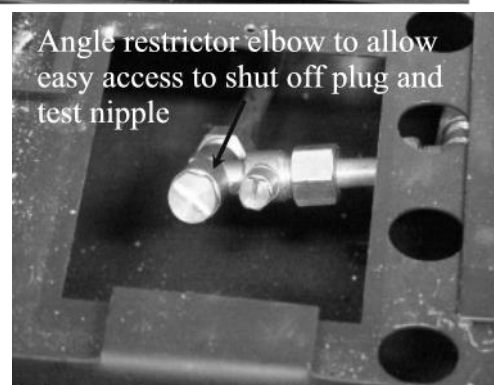
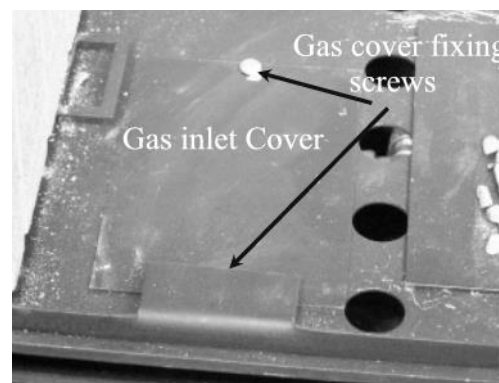

CHECKING GAS SOUNDNESS AND RUNNING PRESSURE.

Batteries must be connected before proceeding with any soundness testing

- Turn on the gas supply to the appliance and check for soundness in accordance with current codes of practice.
- Turn off the gas supply at the external Isolation valve.
- Remove the pressure test point screw from the inlet elbow and connect the pressure gauge.
- Turn on the gas to the appliance at the Isolation valve.
- Light the appliance as described in section 2.
- Check the inlet pressure is 20mbar. +/- 1.0 (Natural Gas) or 37mbar. +/- 1.0 (Propane Gas)
- Turn off gas supply, at the isolation valve. Disconnect the pressure gauge and replace the pressure test point screw.
- Turn on the supply to the appliance and check the pressure test point for soundness with detection fluid.
- **Refit the gas connection cover.**
- Fit the air tray within the location with the burner shelf.

Construction of a false chimney breast front.

- Using 50mm K.D Sawn stud-work will provide the required rebate.
- The vertical sides of the stud-work should not be less than 502mm from the centre of the firebox. The horizontal stud-work should not be less than 764mm from the base of the firebox. This will ensure 50mm minimum clearance from the sides and 110mm clearance from the top of the firebox is maintained.
- An insulation material (20mm "Super lux" or equivalent) should be attached to the underside face of the horizontal stud-work directly above the firebox assembly.
- Line the opening with 12mm thick non-combustible material.

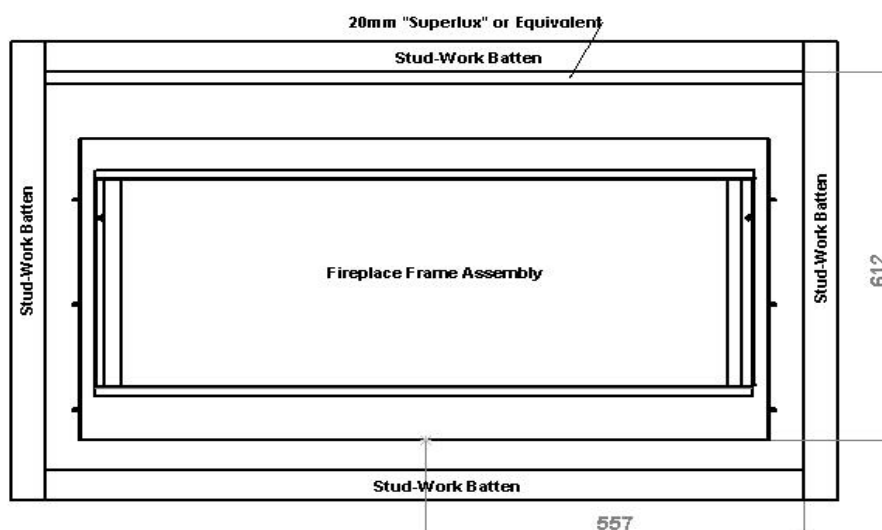

FIT LINERS (See Page 11)

LAY FUEL BED

Important: -

Refer to the Health & Safety Notice located on page 3 of this booklet before laying or replacing any refractory material.

In the event of replacing fuel bed components please use only the specified number of components as illustrated. Only use fuel bed component provided for this appliance. In the interest of safety and efficiency of your appliance when replacing the fuel bed it is essential that the existing fuel bed be removed and the new components are replaced correctly as a complete set.

Lay fuel bed as described under Users Section.

Warning:

It is important that the fuel bed components are positioned as shown in these instructions.

If the fuel bed components are not positioned correctly this may result in damage to the glass.

SECTION TEN Checking Operation of Fire (installation instructions)

REFIT GLASS PANEL AND FIREPLACE FRAME COVERS – (refer to section 3)

CHECKING FOR COMBUSTION PRODUCTS CLEARANCE

IMPORTANT:-The smoke test must be carried out with the fire starting from cold.

- Light the fire and leave at maximum input.
- Close all the doors and windows.
- After five minutes fit the smoke match in a holder and position as illustrated with the head of the match just inside the test opening.
- Run the match along the top edge **All smoke** must be drawn into the test opening if the clearance is satisfactory.
- If spillage occurs wait a further five minutes and repeat the test.
- Repeat the test with doors open and with any extractor fans in other rooms in operation.
- If spillage is detected the cause must be discovered and the fault corrected, if the fault cannot be corrected, disconnect the fire from the gas supply and seek expert advice. Spillage can be caused by a restriction in the flue system, down draught or insufficient ventilation into the room where the fire is installed.

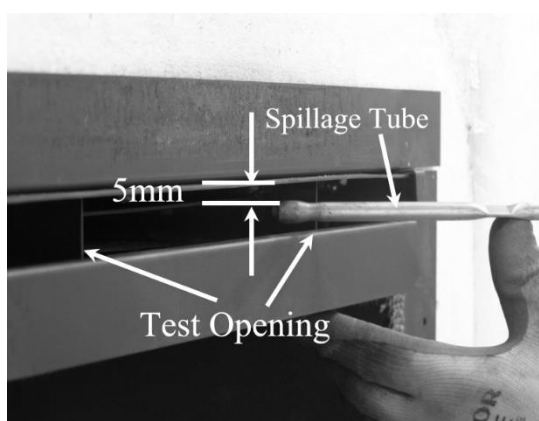

ADVISE CUSTOMER THAT:

- The glass front of this fire acts as a dress guard, conforming to BS 1945 (1997) and satisfies the heating appliance regulations (1991) however; a fireguard conforming to BS6539 (1997) must be used to protect young children, the elderly, or infirm.
- The curing effect of heating the logs and other refractory components will cause an initial odour. This is due to the starch used in the manufacturing process and is non-toxic.
- Any debris should be cleaned from the appliance. A vacuum cleaner can be used but only after all the loose logs have been removed.
- The appliance should be serviced annually by a competent person in accordance with these instructions and the appliance checked for spillage in accordance with the method detailed in these instructions.
- Demonstrate changing the batteries.
- Demonstrate the lighting and extinguishing procedures to the user and the removal and refitting of the glass panel for cleaning. Refer to the user section of this booklet.
- If ventilation is fitted for any reason it must be checked regularly to ensure freedom from obstructions.
- **Hand these instructions over to the user along with the spare batteries and glass removal tool.**

SECTION ELEVEN Maintenance (maintenance instructions)

GENERAL

- Servicing should be carried out annually by a competent person such as a Gas safe-registered person in accordance with the relevant regulations, to ensure the safe and correct operation of the appliance.
- Before commencing any service or replacement of parts, turn off the gas supply to the fire. After servicing check for gas soundness.
- When ordering spare parts please quote appliance name and serial number, these can be found on the data badge, which is located on the right hand side of the appliance behind the trim or fascia.
- At least once a years check for debris in the catchment area behind the fire and in the flue way.
- If soot has accumulated checks to establish cause rectify and clean flue or chimney accordingly.

PILOT LINTING

Check pilot aeration holes for linting, use a vacuum cleaner nozzle taking care not to damage the pilot head.

TO REMOVE THE BURNER TRAY

- Remove RH and LH side covers undo glass fixing.
- Remove glass panel.
- Remove the loose fuel bed components.
- Disconnect battery leads and remove appliance battery pack.
- Remove gas supply cover.
- Disconnect fire at inlet elbow and Undo the three burner tray fixing screws. Pull carefully forward and remove.
- For normal servicing the tray can be cleaned using a vacuum cleaner.
- Whilst the tray is removed vacuum the firebox if necessary.

REPLACEMENT OF GAS CONTROL

- Follow the burner tray removal sequence.
- Disconnect the thermocouple from the rear of the gas valve.
- Undo the three compression nuts securing the pipes to the gas valve and remove the two screws fixing the valve to the bracket.
- Clean, service or replace gas valve.
- Re-assemble in the reverse order.
- Turn on the gas supply, check for soundness and re-commission appliance.

REPLACEMENT OF INJECTOR

- Follow the burner tray removal sequence.
- Undo the compression nut on the supply pipe.
- Unscrew the locking nut holding the injector on the chassis.
- Clean or replace the injector.

NOTE: -Do not use a wire or a drill to clean out holes. Refer to the appliance data section for details.

- Re-assemble in reverse order.

REPLACEMENT OF OXY-PILOT ASSEMBLY

NOTE: If the pilot assembly is replaced it must be replaced by an identical unit from the same manufacturer and replaced as a complete unit.

- Follow the burner tray removal sequence.
- Undo the compression nut on the supply pipe at the pilot.
- Carefully pull off the ignition lead.
- Disconnect the thermocouple at the end of the main control valve.
- Remove the cross headed nut holding the pilot to the chassis
- Carefully remove the pilot shield & oxy-pilot.
- Re-assemble in reverse order.

REPLACEMENT OF CONTROL UNIT (EDB)

- Follow the burner tray removal sequence.
- Disconnect leads from control unit and remove 2 bolts.
- Re-assemble in the reverse order.

Turn on the gas supply, check for gas soundness and re-commission appliance.

SECTION TWELVE Wiring Diagram (maintenance instructions)

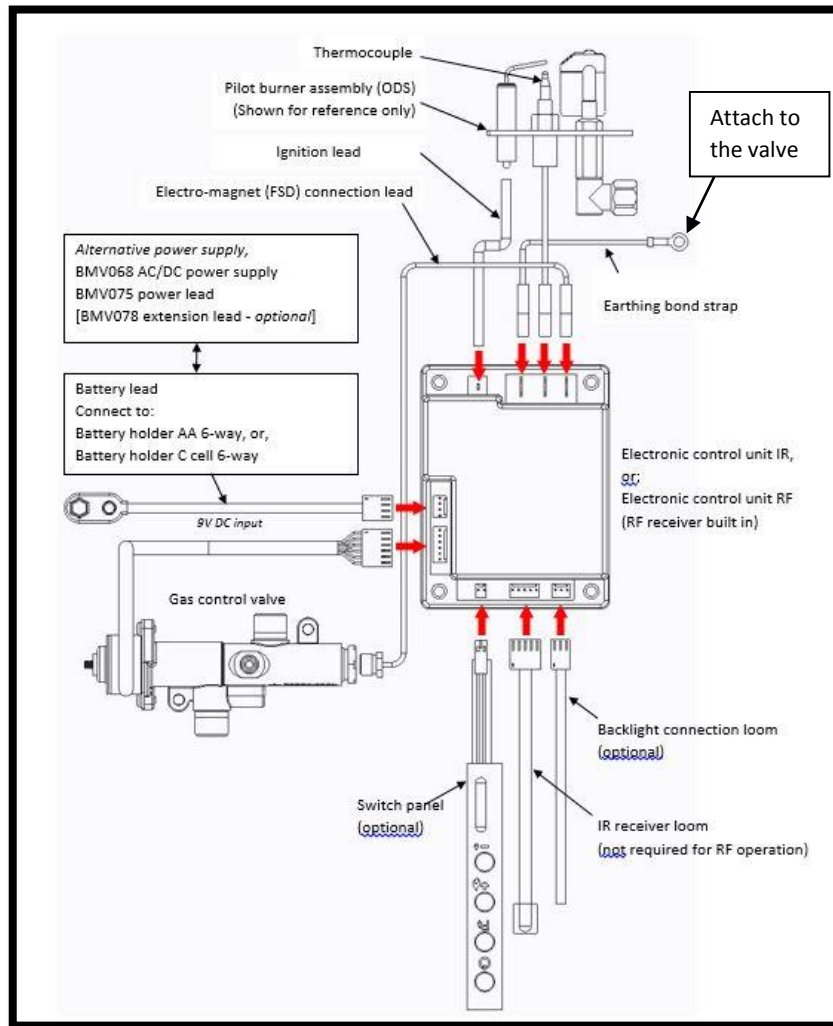

Register your appliance online today to activate your warranty



GAS FIRE COMMISSIONING CHECKLIST

This Commissioning Checklist is to be completed in full by the competent person who commissioned the gas fire as a means of demonstrating compliance with the appropriate Building Regulations and then handed to the customer to keep for future reference.

Failure to install and commission according to the manufacturer's instructions and complete this Benchmark Commissioning Checklist will invalidate the warranty. This does not affect the customer's statutory rights.

Site Requirements	Yes	N/A
Was the chimney checked to ensure it only serves one flue/fire, has no obstructions and is continuous?		
Has any debris at the base of the chimney been removed?		
For brick chimney installations is there enough depth for 12 litres of debris, or precast flues 2 litres of debris? (see instructions for debris gap details)		
Have damper and register plates been removed or locked in the fully open position ensuring correct size of flue is maintained?		
If previously used for solid fuel has the chimney been thoroughly swept?		
If the chimney is pre-cast has the inside of the flue been checked for extruded cement / sealant which must be removed?		
Has the fire place been checked for under-floor air supply which must be sealed off?		
Has the chimney been inspected prior to fitting the gas fire to ensure that it is in good condition?		
Has the structure of the chimney been checked for leakage using a smoke pellet test? (See BS5440-1 for details).		
Ventilation		
Does the installation require any additional ventilation requirements as detailed in the manufacturer's instructions?		
Hearth Requirements- where fitted		
Is the hearth constructed from non -combustible material?		
Is the hearth a minimum of 12mm thick with a minimum floor to top surface of 50mm?(BS5871) or as per manufacturer's instructions?		
Is the hearth for open fronted fires a minimum of 760mm wide and has 300mm projecting from the fire opening (BS6871) or to manufacturer's instructions?		
Mounting height (where applicable) has the fire been installed to the correct mounting height- as per manufacturer's instructions?		
Firebox and Fuel Bed		
Has the fuel bed, coals, pebbles etc. been fitted to manufacturer's instructions?		
Gas Supply		
Has an isolation tap/restrictor inlet elbow been fitted for servicing?		
Has the gas supply been thoroughly purged prior to connection to remove any debris?		
Has a gas tightness test been completed prior to breaking into the gas supply and following completion of installation?(IGEM/UP/1B)		
Record burner gas pressure reading? If only the supply pressure is available a gas rate must be undertaken.(GSIUR REG26/9C)		
Record dynamic inlet gas pressure (working pressure) reading (all gas appliances running)		
Spillage test		
Installation passes smoke match test with any extractor fans turned on (see manufacturer's instructions)		
Installation		
Has the gas fire been installed and commissioned in accordance with manufacturer's instructions?		
Has the fire been installed with the correct clearance to combustible materials, as per manufacturer's instructions?		
The operation of the appliance and controls have been demonstrated to the customer including battery replacement where applicable?		
The manufacturer's literature, including Benchmark Checklist and Service record has been explained and left with the customer?		
Has the appliance been registered with the Local Authority as detailed on the Gas Safe web site and is a legal requirement and forms part of the warranty?		
Customer's Signature: (To confirm satisfactory demonstration and receipt of manufacturer's literature)	Commissioning Engineer's Signature:	

*All installations in England and Wales must be notified to be Local Authority Building Control (LABC) either directly or through a Competent Persons Scheme. A Building Regulations Compliance Certificate will then be issued to the customer.

SERVICE RECORD

It is essential that your gas fire is serviced regularly and that the appropriate Service Interval Record is completed. Service Provider

Before completing the appropriate Service Record below, please ensure you have carried out the service as described in the manufacturer's instructions. Always use the manufacturer's specified spare part when replacing controls.

SERVICE 01	Date:
Engineer name:	
Company name:	
Telephone No:	
Gas safe register No:	
Comments:	
Signature	

SERVICE 02	Date:
Engineer name:	
Company name:	
Telephone No:	
Gas safe register No:	
Comments:	
Signature	

SERVICE 03	Date:
Engineer name:	
Company name:	
Telephone No:	
Gas safe register No:	
Comments:	
Signature	

SERVICE 04	Date:
Engineer name:	
Company name:	
Telephone No:	
Gas safe register No:	
Comments:	
Signature	

SERVICE 05	Date:
Engineer name:	
Company name:	
Telephone No:	
Gas safe register No:	
Comments:	
Signature	

Product ID Label	A-0272	Serial No Prefix	MA (Ng)
Burner Tray / Box Assembly			
Complete Log Fuel Bed (5752)			
Grommet (1092)			
1 X Bag of Black Chippings (6462)			
1 X Bag Of Black/Fawn Chippings (5855)			
Glass Panel			
Air Tray (5773)			
Silicone Sealing Strip (4818)			
'C' Cell Battery (12)			
Remote Control Hand Set			
Battery Holder			
Handset Holder (Part No 5910)			
AAA Battery (3)			
Owners Book			
7mm Spinner (5435)			
Data Badge			
Warning Label (1409)			
ID Label & Packing Labels			
Serial Number			
Inspector			

Product ID Label	A-0339	Serial No Prefix	MV (LPG)
Burner Tray / Box Assembly			
Complete Log Fuel Bed (5752)			
Grommet (1092)			
1 X Bag of Vermiculite (5880)			
1 X Bag Of Black/Fawn Chippings (5855)			
Glass Panel			
Air Tray (5773)			
Silicone Sealing Strip (4818)			
'C' Cell Battery (12)			
Remote Control Hand Set			
Battery Holder			
Handset Holder (Part No 5910)			
AAA Battery (3)			
Owners Book			
7mm Spinner (5435)			
Data Badge			
Warning Label (1409)			
ID Label & Packing Labels			
Serial Number			
Inspector			