

Owner's Manual

INCLUDES

User, Maintenance, Service, and Installation
Instructions



FOCUS HE SLIMLINE



Keep this booklet for service log and future reference

IMPORTANT



This appliance is guaranteed for 12 months subject to conditions. The 5 year extended parts warranty will only be valid if the annual service recommended in this manual has been completed and appliance has been registered online.

For use in Great Britain and Ireland.

Literature NO 5315 (ISS 8)

Contents

EXTENDED FIVE YEAR PARTS WARRANTY	2
Benchmark Scheme	3
SECTION ONE Important Information (user instructions).....	5
SECTION TWO Operation (user instructions)	6
SECTION THREE Fuel Bed Cleaning and Layout (user instructions).....	7
SECTION FOUR Cleaning (user instructions).....	11
SECTION FIVE General Points (user instructions)....	13
SECTION SIX Appliance Data (installation instructions).....	14
SECTION SEVEN Regulations and Warnings (installation instructions).....	15
SECTION EIGHT Siting the Appliance (installation instructions).....	17
SECTION NINE To Install the Appliance (installation instructions).....	19
SECTION TEN Checking Operation of Fire (installation instructions).....	21
SECTION ELEVEN Maintenance (maintenance instructions).....	23
GAS FIRE COMMISSIONING CHECKLIST.....	26
SERVICE RECORD.....	27



EXTENDED FIVE YEAR PARTS WARRANTY

In order to validate your extended 5 years parts warranty please read the Benchmark Scheme on the opposite page and ensure your installer has filled in the appropriate checklist.

This in no way reduces your statutory rights

Your warranty commences from the date of purchase and you must retain your receipt or invoice as proof of a purchase date.

THIS EXTENDED WARRANTY SPECIFICALLY EXCLUDES GLASS AND SOFT REFRACTORY COMPONENTS, THE BULB AND ANY BATTERIES.

Terms and Conditions

1. The appliance must be installed by a GAS SAFE registered person.
2. The appliance must be used in accordance with the user's instructions.
3. The appliance must be serviced annually by a GAS SAFE registered person.
4. The benchmark and service log must be correctly filled out and the record of annual services must be up to date and supported by receipts in each case.
5. This warranty is not transferable and relates to the original installation only.
6. The appliance has not been subjected to misuse or accident or been modified or repaired by any person other than the authorised employee or authorised representative of Charlton and Jenrick Ltd.
7. The registration form must be returned within 1 month of purchase.

Benchmark Scheme



Charlton and Jenrick Ltd is a licensed member of the Benchmark Scheme which aims to improve the standards of installation and commissioning of domestic heating and hot water systems in the UK and to encourage regular servicing to optimise safety, efficiency and performance. Benchmark is managed and promoted by the Heating and Hotwater Industry Council. For more information and the full code of practice please visit www.centralheating.co.uk

Please ensure that the installer has fully completed the Benchmark Checklist on the inside back pages of the installation instructions supplied with the product and that you have signed it to say that you have received a full and clear explanation of its operation. The installer is legally required to complete a commissioning checklist as a means of complying with the appropriate Building Regulations (England and Wales).

All installations must be notified to Local Area Building Control either directly or through a Competent Persons Scheme. A Building Regulations Compliance Certificate will then be issued to the customer who should, on receipt, write the Notification Number on the Benchmark Checklist.

This product should be serviced regularly to optimise its safety, efficiency and performance. The service engineer should complete the relevant Service Record on the Benchmark Checklist after each service.

The Benchmark Checklist will be required in the event of any warranty.

It is a requirement that the gas fire is installed and commissioned to the manufacturer's instructions and the data fields on the commissioning checklist completed in full.

To instigate the guarantee, the gas fire needs to be registered with the manufacturer within one month of the installation.

To maintain the guarantee, it is essential that the gas fire is serviced annually by a Gas Safe registered engineer. The service details should be recorded on the Benchmark Service Interval Record and left with the householder.

Important

For future reference we suggest you record the following details here, and keep the receipt as proof of purchase. This information may be asked for when you contact the helpdesk.

MODEL:	FOCUS HE SLIMLINE	Serial No.	
---------------	--------------------------	-------------------	--

This information can be found on the label attached to the packaging and on the data badge, which is located on the base of the appliance behind the control cover.

Retailer Name:	
Address:	
Date Of Purchase:	

Installer information required to register for the extended warranty

Name:	
Date of installation:	
Gas safe number:	

SECTION ONE Important Information (user instructions)

Consumer protection information

As manufacturers and suppliers of heating products, we take every care, as far as is reasonably practicable, that these products are so designed and constructed as to meet the general safety requirement when properly used and installed. To this end, our products are thoroughly tested and examined before despatch.

IMPORTANT NOTICE: Any alteration that is not approved by the appliance manufacturer could invalidate the approval of the appliance, operation of the warranty and could affect your statutory rights.

Health and Safety Notice

Important

This appliance could contain some of the materials, indicated below, that could be interpreted as being injurious to health and safety. It is the users / installers responsibility to ensure that the necessary personal protective clothing is worn when handling these materials, see below for information.

Artificial Fuels, Mineral Wool, Insulation Material, Refractory/Ceramic Fibres, Glass Yarn - *may be harmful if inhaled, may be irritating to skin, eyes, nose and throat.*

When handling *avoid inhaling and contact with skin or eyes. Use disposable gloves, facemasks and eye protection. After handling wash hands and other exposed parts. If a vacuum is used for cleaning the coals or cleaning after servicing / installation it is recommended that it be of the type fitted with a HEPA filter.*

Disposal of refractory/ceramic materials. To keep dust to a minimum these materials should be securely wrapped in polythene and be clearly labelled 'RCF waste'. These materials are not classified as 'hazardous waste' and should be disposed of at a site licensed for the disposal of industrial waste.

- The FOCUS HE SLIMLINE is a decorative fuel effect appliance with a radiant heat conserver box and glass panel for improved efficiency.
- The FOCUS HE SLIMLINE incorporates a single gas control, which selects ignition pilot, and variable settings between Low and High.
- This appliance is intended for decorative purposes.
- The FOCUS HE SLIMLINE appliance is designed and tested to the requirements of the EN 509.
- The appliance is for use on Natural Gas only.
- The chimney or flue (unless new or previously used with a gas appliance) must be swept before installation if it has been used for solid fuel.

WARNING

The glass front of this fire acts as a dress guard, conforming to BS 1945 (1997) however; a fireguard conforming to BS6539 (1997) must be used to protect young children, the elderly or infirm.

Clothing or other combustible materials must not obstruct the slots at the top of the fire or the base of the appliance.

SOFT FURNISHINGS

Care must be taken to prevent any damage being caused to surrounding soft furnishing or decoration; e.g. many embossed vinyl wall coverings may become discoloured if placed too close to the appliance. Combustible material i.e. wall panelling or wallpaper must be removed from behind the fire and fire trim.

INTRODUCTION

The FOCUS HE SLIMLINE incorporates a single gas control, which selects ignition pilot, and main burner low and high settings.

The appliance incorporates a safety device in the form of an Oxygen Depletion System, which constantly monitors the oxygen in the room and will cause the fire to switch off if the oxygen level reduces, for instance due to insufficient ventilation or a blocked flue.

If this regularly occurs do not attempt to relight the appliance until a qualified engineer has checked it, the problem may not be due to lack of air or a defective flue.

A fire front (fret) must be used with this appliance.

In GB, the appliance must be installed by a competent person i.e. GAS SAFE-registered, in accordance with the GAS SAFETY (INSTALLATION AND USE) REGULATIONS, The Building Regulations (or The Building Regulations (Scotland) or The Building Regulations (Northern Ireland)) and The Current I.E.E. Wiring Regulations, if appropriate.

In IE, the appliance must be installed by a competent person and installed in accordance with the current edition of I.S.813 Domestic Gas Installation, the current Building Regulations and the current ETCI rules for electrical installation, if appropriate.







The pilot can be left on or the pilot can be extinguished and relit each time the fire is used.

During the normal operation of the fire some black staining may appear on some parts of the fuel bed. This is quite normal and adds to the appearance of the appliance. However, if excessive black staining does occur it may be due to the fuel bed being incorrectly laid. This should be checked prior to contacting a service engineer.

SECTION TWO Operation (user instructions)

- **Do not use the fire with the glass safety screen removed, or if the glass is cracked.**
- **Do not use the fire with the canopy removed.**
- The pilot can be left on or the pilot can be extinguished and relit each time the fire is used.
- The appliance Control Knob is positioned behind the fret.

The full lighting procedure is as follows: -

- A. Push knob in as far as possible on gas control.
- B. Turn knob anti-clockwise until a click is heard. The knob will stop at the position marked  and a spark should be seen at the tip of the ignition probe. At the same time the pilot flame should light. KEEP THE KNOB PRESSED IN FOR 20 SECONDS. Should the pilot fail to light, turn the control knob clockwise to the  position, wait 3 minutes and repeat the procedure.
- C. After lighting the pilot flame the control knob should be allowed to spring out slightly. This will allow you to turn the knob further anti-clockwise to the position marked . The pilot flame should then ignite the main fire.
- D. It is possible to adjust the height of the flames by turning the control knob between the positions marked  and . Note that the knob 'latches' in position at either end of this movement and must be pushed in slightly before it can be turned.
- E. To turn the fire off, depress the knob slightly and turn it to the  position.
- F. To completely extinguish the fire, depress the knob slightly and turn to  the position.

Note: - If the ignition fails the pilot can be lit with a taper or a match held at the pilot head.

SECTION THREE Fuel Bed Cleaning and Layout (user instructions)

Warning: - Before you clean any part of the appliance ensures that the appliance is turned off and cold.

Important: - Refer to the Health & Safety Notice located on page 5 of this booklet before cleaning or replacing any refractory material.

The fuel bed components are delicate and they should be handled with great care.

The loose parts and moulded shapes may be removed for cleaning. They can be brushed very gently with a soft brush to remove dust or any deposits.

A vacuum cleaner may only be used after the loose components and moulded shapes have been removed.

CARE SHOULD BE TAKEN TO AVOID CONTACT WITH THE REFRACTORY LINING THIS IS A DELICATE SURFACE AND SHOULD **NOT** BE WIPED OR RUBBED.

REMOVING GLASS PANEL

- Remove the trim, which is held in position with magnets.
- Remove the fret and ash pan cover.
- Lift of the canopy and remove.
- Remove the glass fixing clamp secure with three securing nuts and lift it out of the retaining brackets. Take care to support the glass panel when removing the fixing clamp. The glass should be place in a safe place to prevent damage.
- Once the fuel bed has been laid reassemble in reverse order.

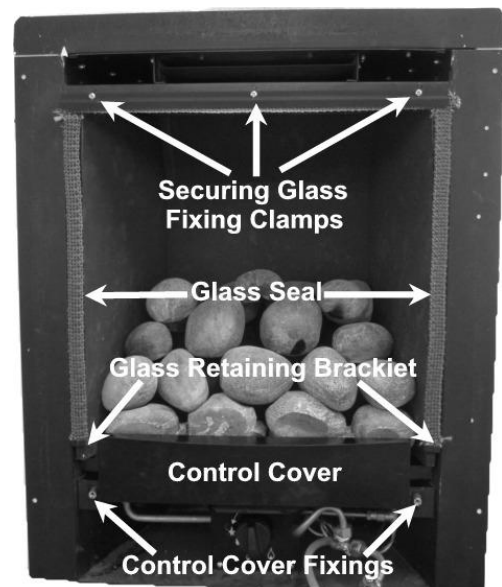

FUEL BED LAYOUT (COAL OPTION)

6 OFF "A" Coal Shapes

9 OFF "B" Coal Shapes



- Ensure the BASE MATRIX is in position as shown located against the rear edge of the burner outlet.



- Locate the Front Matrix as shown.

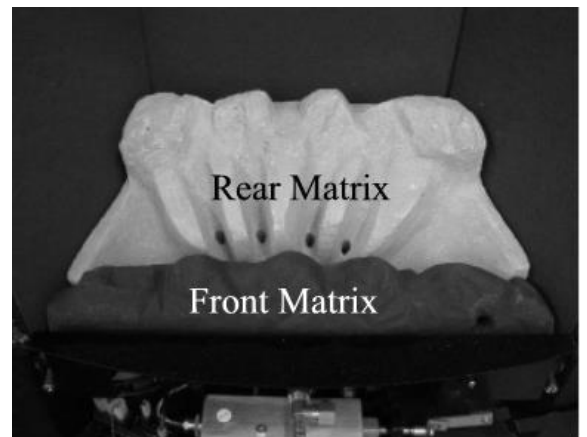

- Locate the first row of coals within the location points in the front matrix.

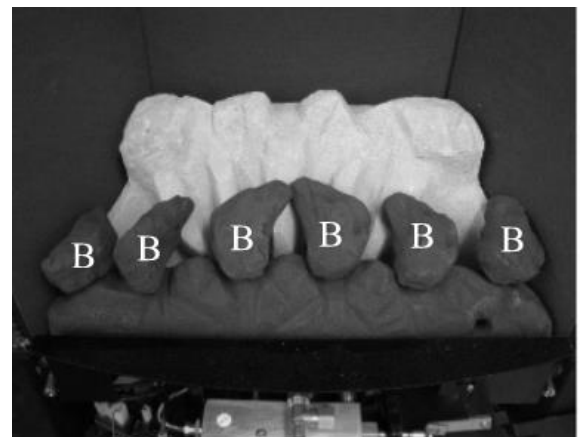

- Lay a second layer of coals as shown.

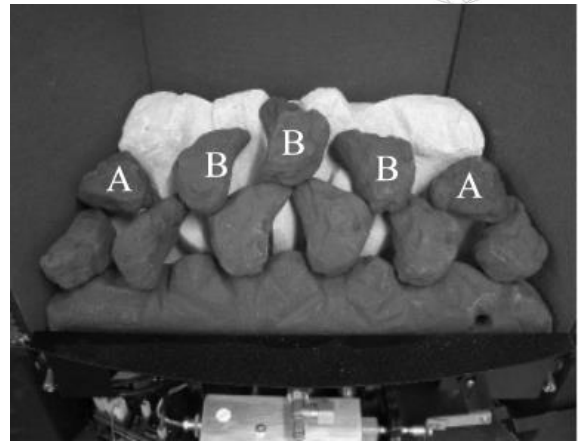

- Lay the third layer of coal as shown.

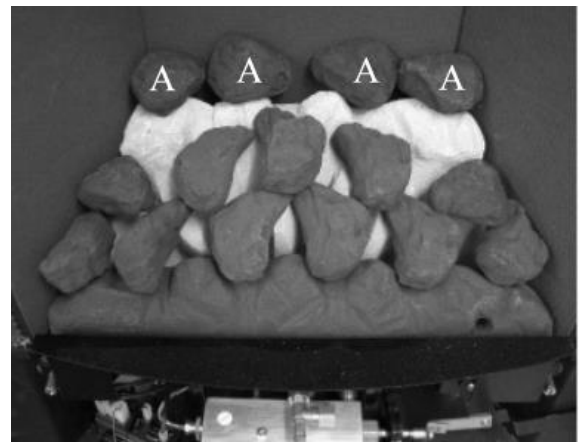

- Refit glass panel, heat shield, canopy, trim and fret.

FUEL BED LAYOUT (PEBBLE OPTION)

- 6 OFF "D" Pebble Shapes
- 9 OFF "B" Pebble Shapes



- Ensure the REAR MATRIX is in position as shown located against the rear edge of the burner outlet.

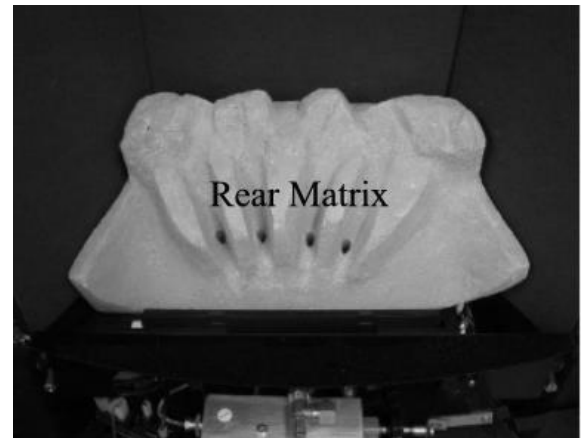

- Locate the Front Matrix as shown.

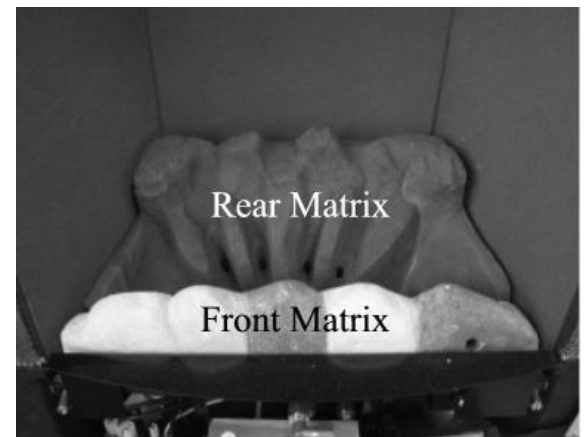

- Locate the first row of Pebbles within the location points in the front matrix.

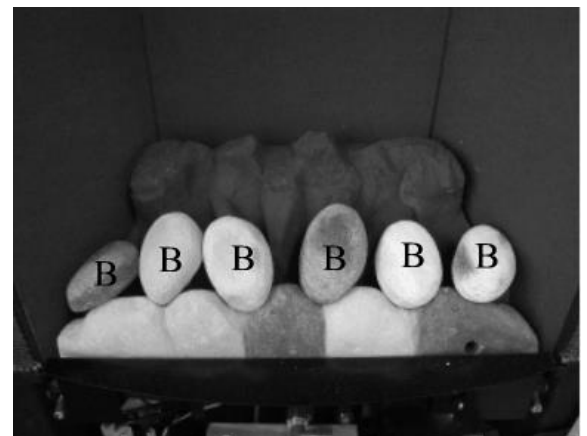

- Lay a second layer of Pebbles as shown.



- Lay the third layer of coal as shown.



Note: The appliance MUST not be used if the canopy or glass panel is missing or damaged.

[SECTION FOUR Cleaning \(user instructions\)](#)

CLEANING: BRASS

The brass fret and brass effect fire surround trim may be cleaned with a clean damp cloth.

N.B The trim and fire front should be removed for cleaning. (The trim is held in place by magnetic strips).

CLEANING: BLACK PAINTED SURFACES

- These surfaces should be dusted regularly and any marks removed with a soft cloth.
- Abrasive or chemical cleaner should **never** be used for cleaning these surfaces.

GLASS CLEANING

Note: - The glass may discolour quickly when first installed, and it should be cleaned. This is due to the burning off process of the refractory shapes.

*From time to time it will be necessary to clean the glass panel. We recommend you use a Ceramic hob cleaner these are available for all leading supermarkets: - i.e. **ASDA, TESCO, SAINSBURY'S** Etc.*

Brands of hob cleaning we have tested and found suitable are - **HOB BRITE & VITRO CLEN.**

Ensure that the appliance is cold before cleaning the glass.

To remove glass panel for cleaning:

- Remove trim, which is held in position with magnets.
- Remove the fret and ash pan cover.
- Lift of the canopy and remove.
- Remove the glass fixing clamp secure with three nuts and lift it out of the retaining brackets. Take care to support the glass panel when removing the fixing clamp.
- Lay the glass panel down on a flat working surface on top of an old opened newspaper with the side to be cleaned uppermost.
- Follow the instructions on the Hob Cleaner Bottle.
- On stubborn stains (where the appliance as been used for a long period without glass panel being cleaned), use a new Brillo Pad well wetted with the Hob cleaner applied directly to it.
- Ensure all the residues of the cleaner are removed with a damp cloth and the glass panel is completely dry before fitting to the appliance.
- Check that the coals are correctly placed before reassembling in reverse order.

Note: The appliance MUST not be used if the canopy or glass panel is missing or damaged.

CLEANING: PILOT ASSEMBLY

Pilot Cleaning (Before cleaning ensure that the appliance is turned off and cold)

In some instances you may experience ignition problems even when the appliance is new. This may be due to the aeration hole in the pilot body (see photograph) being partial blocked with dust, pet hairs or other foreign matter. The source of this debris could be such things as carpet fibres, decorating or pet etc.

To clean the pilot, remove the fire front and ash pan. The pilot is located on the right hand side of the appliance, any debris in or around the aeration hole should be remove using the nozzle of a vacuum cleaner. It is advisable not to blow the debris into the hole as this may cause more of a restriction and not rectify the problem.

Note: - Take care when cleaning in this area so as not to damage the pilot assembly.

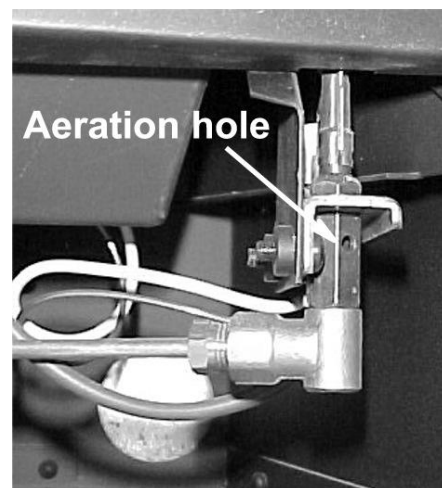

SECTION FIVE General Points (user instructions)

Like all appliances incorporating an aerated burner a low frequency noise may be heard.

It is advised that the FOCUS HE SLIMLINE fire be serviced annually by a competent person. The fire is more likely to provide trouble-free operation. The actions given below should be carried out during that service.

Dulling and slight discoloration inside the firebox will occur adding to the realism of the appliance, this is quite normal.

It is important that: -

- The chimney or flue is checked annually to ensure clearance of combustion products.
- The fire front must be positioned in front of the fire whilst it is burning
- Any debris from the chimney or flue should be removed. The fire should be allowed to cool before it is removed.
- The fire must not be used if the glass panel is not fitted or damaged - this includes the seal.
- The fire must not be used if the canopy is not fitted.
- The data badge is located behind the fret on the right hand side of the appliance.

The only user removable parts are: -

- Fret
- Refractory Fire bed Components
- Canopy.
- Trim.
- Glass panel.

SECTION SIX Appliance Data (installation instructions)

Category of Appliance...BAS

Category.....J2H

Gas Type.....G20

Gas Pressure:.... 20 mbar +/- 1.0mbar

Gas Input (Gross)..... 4.2 kW (Max.)
2.40 kW (Min)

Injectors:.....Size 290

Oxy-pilot.....9044NG

Data Badge Location:(Behind trim) right hand side of the appliance.

Gas Connection:.....8mm OD tube.

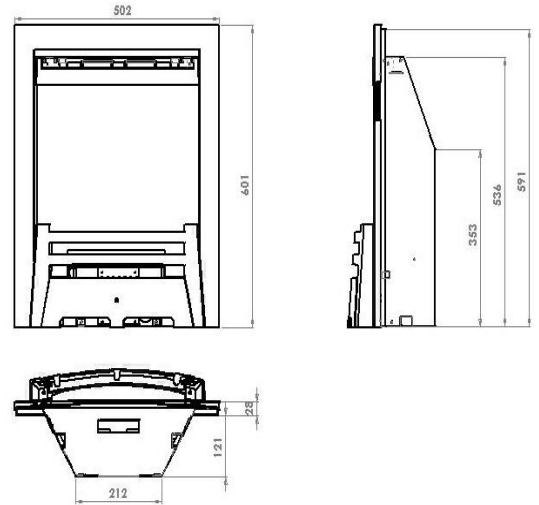

NOTE: The efficiency of this appliance has been measured as specified in BS7977-1 2009 + A1:2013 and the result is 71.3%. The gross calorific value of the fuel has been used for this efficiency calculation. GasTec have certified the test data from which it has been calculated. The efficiency value may be used in the UK Government's Standard Assessment Procedure (SAP) for energy rating of dwellings.

PACK CONTENTS

When unpacking the appliance please check the following items are included:

- Appliance (10.5kg)
- Owners Manual
- Wire fixing kit
- Foam seal
- Trim (1.5kg)
- Fret and ashpan cover (4kg Max)
- Refractory Fuel Bed Components (Rear Matrix Front Matrix and Loose Coals).

SECTION SEVEN Regulations and Warnings (installation instructions)

Consumer Protection information

As manufacturers and suppliers of heating products, we take every care, as far as is reasonably practicable, that these products are so designed and constructed as to meet the general safety requirement when properly used and installed. To this end, our products are thoroughly tested and examined before despatch.

IMPORTANT NOTICE: Any alteration that is not approved by the appliance manufacturer could invalidate the approval of the appliance, operation of the warranty and could affect your statutory rights.

Health and Safety Notice

Important

This appliance could contain some of the materials, indicated below, that could be interpreted as being injurious to health and safety. It is the users / installers responsibility to ensure that the necessary personal protective clothing is worn when handling these materials, see below for information.

Artificial Fuels, Mineral Wool, Insulation Material, Refractory/Ceramic Fibres, Glass Yarn - *may be harmful if inhaled, may be irritating to skin, eyes, nose and throat.*

When handling *avoid inhaling and contact with skin or eyes. Use disposable gloves, facemasks and eye protection. After handling wash hands and other exposed parts. If a vacuum is used for cleaning the coals or cleaning after servicing / installation it is recommended that it be of the type fitted with a HEPA filter.*

Disposal of refractory/ceramic materials. To keep dust to a minimum these materials should be securely wrapped in polythene and be clearly labelled 'RCF waste'. These materials are not classified as 'hazardous wa' and should be disposed of at a site licensed for the disposal of industrial waste.

MANUAL HANDLING GUIDANCE

Do not handle appliance unless: -

- You have received up to date manual handling training.
- Your supervision / leadership is adequate.

When handling: -

- One fully fit person should be able to lift this appliance. If you consider this weight to be excessive then you must obtain assistance.
- Gloves and safety shoes must be worn.
- Use hand holes provided in the carton.
- Bend using legs keeping back straight.
- Reposition feet rather than twisting at waist.
- Do not lean forwards or sideways.
- Always grip with palm of hand and not fingertips.

Unpacking the appliance:-

- Cut tape located at top of box and open box.
- Remove loose items located in side retainers.
- Remove cardboard side retainers.
- Remove fire assembly
- Packaging should be disposed off in line with your companies environmental / recycling procedure.

- **THIS APPLIANCE MUST ONLY BE INSTALLED IN Great Britain OR IRELAND.**
- **THE APPLIANCE IS SUITABLE FOR USE ON NATURAL GAS ONLY.**
- **THE APPLIANCE IS INTENDED FOR DECORATIVE PURPOSES.**
- **(GB) NO SPECIAL VENTILATION BRICKS OR VENTS ARE REQUIRED INTO THE ROOM CONTAINING THE APPLIANCE, PROVIDING NORMAL ADVENTITIOUS ROOM VENTILATION EXISTS. THE INSTALLER MUST SATISFY THIS POINT BY CARRYING OUT THE MANDATORY SPILLAGE TEST.**
- **(IE) PERMANENT VENTILATION MUST COMPLY WITH THE CURRENT EDITION OF IS813.**
- **In GB. IT IS THE LAW THAT ALL GAS APPLIANCES MUST BE INSTALLED BY A COMPETENT PERSON; I.E. A GAS SAFE REGISTERED INSTALLER, IN ACCORDANCE WITH THE CURRENT GAS SAFETY (INSTALLATION AND USE) REGULATIONS (AS AMENDED), ALL RELEVANT PARTS OF THE LOCAL AND NATIONAL BUILDING REGULATIONS AND ALL RELEVANT RECOMMENDATIONS OF THE FOLLOWING BRITISH STANDARDS. FAILURE TO DO SO COULD LEAD TO PROSECUTION.**

- **IMPORTANT NOTE:- The fire front (fret) supplied must be used with this appliance.**

THE FOLLOWING ARE RELEVANT CODES OF PRACTICE AND BRITISH STANDARDS: -

BS 5871 BS 8303 BS 5440 PART 1 BS 1251BS 6891

BS 6461 PARTS 1 AND 2 BS 715 BS 1289 PART 1

Note: - This appliance must be installed to current versions of the above standards and include any relevant amendments.

THE BUILDING REGULATIONS ISSUED BY THE DEPARTMENT OF THE ENVIRONMENT.

THE BUILDING STANDARDS (SCOTLAND) (CONSOLIDATED) REGULATIONS ISSUED BY THE SCOTTISH DEVELOPMENT OFFICE.

IN IE, THE APPLIANCE MUST BE INSTALLED BY A COMPETENT PERSON AND INSTALLED IN ACCORDANCE WITH THE CURRENT EDITION OF I.S.813 DOMESTIC GAS INSTALLATION, THE CURRENT BUILDING REGULATIONS AND THE CURRENT ETCI RULES FOR ELECTRICAL INSTALLATION ,IF APPROPRIATE.

PRIOR TO THE INSTALLATION ENSURE THAT THE LOCAL DISTRIBUTION CONDITIONS

(IDENTIFICATION OF TYPE OF GAS AND PRESSURE) AND ADJUSTMENT OF THE

APPLIANCE ARE COMPATIBLE. (G20 @ 20mbar)

WARNINGS

- The glass front of the fire act as a dress guard, conforming to BS 1945 (1971) and satisfies the heating appliance regulations (1991) However, a guard conforming to BS6539 (1984) must be used to protect young children, the elderly or infirm.
- **This appliance incorporates a safety device in the form of an Oxygen depletion system. IT MUST NOT BE ADJUSTED OR PUT OUT OF OPERATION! THIS IS A NON SERVICABLE ITEM AND MUST BE EXCHANGED AS A COMPLETE ASSEMBLY; USING ONLY THE ORIGINAL MANUFACTURER'S PART.**
- A non-combustible hearth must be provided to comply with the building regulations, or a suitable proprietary fire surround with a 150°C minimum rating. See Section 8.
- During initial firing, an odour may be evident. This is the starch binder used during the manufacture of the fibre components of the fire, and there are **no harmful** effects produced.
- Care must be taken to prevent any damage being caused to surrounding soft furnishing or decoration; e.g. many embossed vinyl wall coverings may become discoloured if placed too close to the appliance.

SECTION EIGHT Siting the Appliance (installation instructions)

The fire can be installed in the following locations: -

CLASS ONE & CLASS TWO & PRE-CAST

A conventional brick or stone chimney as used for a solid fuel appliance with an effective cross-sectional dimension of 225 x 225 mm (9 x 9 INS) or a clay/ceramic/metal lined flue with a minimum diameter of 125mm (5 INS). A prefabricated gas flue system with a minimum diameter of 125mm (5 INS). The chimney should be swept prior to installation if previously used with solid fuel or oil appliances. It is not necessary if the flue is new or previously used with a gas appliance. The chimney to have a minimum effective height of at least 3 metres. Any permanent flue restriction or variable dampers are to be removed or locked fully open.

A pre-cast flue correctly constructed conforming to the requirements of BS 1289: 1975, 1986 or 1989 with a minimum effective overall height of 3 metres (10 ft) which is correctly terminated (see BS 5440). It will normally require an additional thickness of 25mm in the form of a fireplace back panel or if it is intended to be fitted back to the plaster line then a spacer may be required to meet with the minimum depth requirement.

IMPORTANT: - The flue restrictor is made up of 3 snap-off plates and needs to be removed for 5" and pre-cast flues

Note: An inspection should be made to ensure that the internal walls of the flue are clear of mortar fangs. It is recommended that the plasterwork should not be directly bonded to the surface of the flue blocks, ensuring that there is a small air gap between the flue blocks and the wall surface. The fire can be installed with the plasterwork being directly bonded to the flue blocks but there is a risk of surface cracking occurring to the plaster above the appliance.

INSTALLATION REQUIREMENTS INTO THE FIREPLACE

The front face and the base of the fire opening must be flat to ensure that a good seal is formed between the rear and base of the appliance and the chimney to avoid any reduction of natural draught. A minimum depth of 170 mm is required into the fireplace if the chimney has previously been used with solid fuel or oil appliances. A minimum depth of 140 mm is required into the fireplace if the chimney is new or has only been used with gas fires previously. If insufficient depth is found, spacer frames can be obtained from the manufacturer to increase installation depth (see diagram).

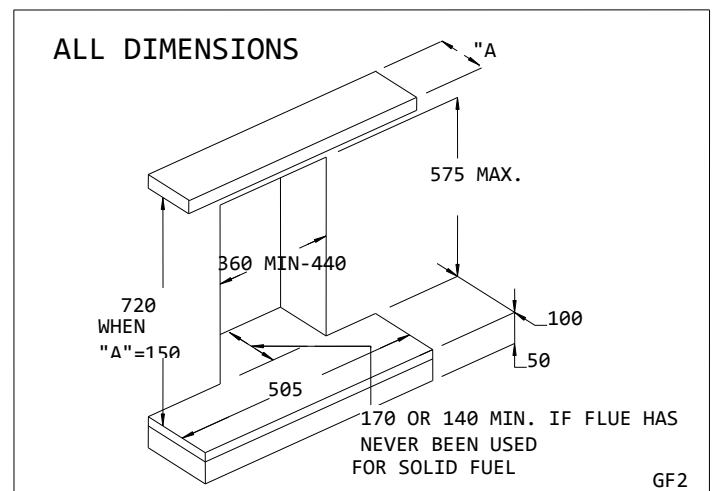

HEARTH

The fire can be fitted in either a conventional hearth see diagram (I.E Tile fireplace etc), or plinth mounted, as a hole-in-the-wall installation

HOLE IN THE WALL

The fire may be installed without a traditional fireplace, if it is installed this way, ensure the base of the fire opening is at least 50mm (2") from the floor surface. It will also be necessary for a non-combustible shelf or plinth to be provided to support the fire front, A suitable shelf or plinth would need to project from the fixing plain of the fire a minimum of 100mm and be at least as wide as the appliance (505mm)

IMPORTANT NOTE when the fire is installed without a fireplace or non-combustible back panel any wall surface or covering that comes in contact with the appliance and is not non-combustible must be removed.

PURPOSE BUILT HEARTH AND SURROUND

Purpose built superimposed fire-resistant hearths and back panels, specified as suitable by the manufacturers, may be used, or a suitable proprietary fire surround with a 150°C minimum rating.

SOFT FURNISHINGS

Care should be taken to prevent any damage being caused to surrounding soft furnishings or decoration e.g. many wall coverings may become discoloured if placed too close to the appliance.

LIMITATIONS OF COMBUSTIBLE MATERIAL

Combustible material must be removed from the front the area behind the decorative trim.

Clearance to Shelf

Minimum clearance from hearth to underside of combustible shelf should be 660mm for a 100mm (4") shelf or 720mm for a 150mm (6") shelf , other sizes of shelf and clearances can be established using the "Shelf Chart"

Note: Ensure no combustibles are lower than 630mm above hearth.

Clearance to Sides of Fire

Minimum width between vertical sides of combustible surround should not be less than 700 mm provided fire is central to the surround and sides do not project more than 150 mm. When vertical side forward projection is increased by 12.5 mm add 50 mm to inside width of surround.

NOTE: - A minimum clearance of 50mm each side is required to non-combustible materials this is to allow for servicing. The minimum clearance to a combustible sidewall is 250mm.

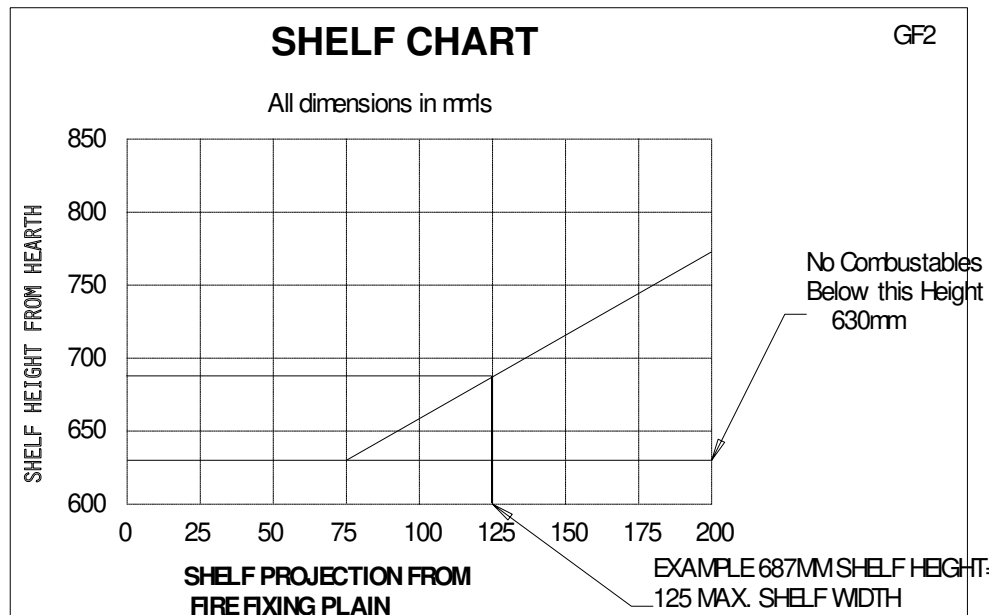

SECTION NINE To Install the Appliance (installation instructions)

CHECKING THE FLUE AND FIRE OPENING

- Check that the chimney conforms to the required specifications as previously stated. Examine the condition and carry out any remedial work including any removal of debris from the base.
- If the flue has been used for solid fuel it should be swept prior to the installation
- Prior to installing the appliance a smoke test (using a smoke bomb) should be carried out to check that satisfactory smoke clearance has been established.

If all the smoke is not drawn into the flue, pre-heat the flue with a blowtorch or similar and re-check. If there is any uncertainty examine for the cause and, if necessary, seek expert advice.

No combustible material shall be fitted inside the fireplace opening.

- When installing this appliance against a dry lined (plasterboard) wall ensure that any void between the plasterboard and the wall is sealed with a suitable non-combustible material (i.e. plaster or mortar).

CONNECTING THE GAS SUPPLY (AND ROUTING)

- Use rigid or semi – rigid tube to connect the gas supply. Determine the gas supply-piping route to the appliance before installing the fire. This may be from the front of the unit, either from the left or from the right hand, or it can be a concealed fitting from the rear of the appliance, via the grommet hole in the rear of the appliance casing ensure the grommet is pushed back into position after routing pipe work.
- A means of isolation from the gas must be provided for the appliance. An isolation elbow is provided for this purpose it may be positioned under the appliance burner (for a concealed connection) immediately adjacent to the appliance connection or either side of the appliance for front connecting.

GLASS PANEL REMOVAL/REFITTING

- Lift of the canopy and remove the refractory heat shield located in front of the glass panel.
- Remove the glass fixing clamp secure with two wing nuts and lift it out of the retaining brackets. Take care to support the glass panel when removing the fixing clamp.
- Replace in reverse order making sure that you engage the top and bottom catches properly and that there are no leaks around the glass seal. Ensure that the glass seal is position correctly (see above) thus minimising its visibility when the canopy is fitted.
- Ensure that the wing nuts are tightened evenly and the glass seal is compressed.

Note: The appliance MUST not be used if the canopy or glass panel is missing or damaged.

CONNECTING THE GAS SUPPLY

Note:- An isolation valve (supplied) should be fitted in the gas supply .This will facilitate servicing.

For a concealed connection: -

- After removing the glass panel as described above.
- Remove the burner by undoing the two screws in the securing it into the burner support, and lift the burner away.
- Remove carefully the four piece refractory back linings and put safely aside.
- Remove the burner engine assembly by undoing the four fixing screws (2 in the engine top and 2 in the engine front) and slide the engine forward to clear the rear location.
- Remove the rubber (blind) grommet from the supply pipe inlet hole at the rear of the outer box and slide the box over the supply pipe and fix to the surround using one of the methods described in the next section.
- Refit the grommet over the pipe to ensure the seal around the inlet hole.
- Refit the burner engine and make connection between the supply isolating valve and the burner engine assembly inlet.
- For left hand or right hand (unconcealed) front gas connection, remove the appliance engine as described pervious and fix box to the surround as described in the next section.
- Refit the burner and run supply from left or right.

FIXING FIRE INTO OPENING

NOTE: -Remove the glass panel and put safely to one side. Do not replace until installation is completed.

- Mark the position of flange holes required in the fireplace front, drill and insert wall plugs
- Remove the paper back from the length of seal and stick it around the rear of the front flange of the fire.

NOTE: -The seal must be positioned to ensure an airtight seal when the appliance is fitted.

- Fix the fire box in position with wood screws.

OPTIONAL CABLE FIXING SYSTEM

Using a No 14 masonry bit drill four holes in the rear wall within the range shown, fit rawl plugs provided and screw eyebolts securely into plugs.

- Remove paper back from length of seal around the rear flange of the fire.

NOTE: -The seal must be positioned to ensure an airtight seal when the appliance is fitted.

- Position the fire close to fireplace, allowing sufficient access to thread the cable through the eyebolts. Feed the cables (one cable to each side) through the top holes in the firebox, through the eyebolts, and back through the bottom holes in the firebox as shown.
- Push firebox fully back in the fireplace opening, allowing it to seal against it to seal against the surround.
- Feed the cables through the adjusters and cable clamps and slide the clamps up the adjusters. Pull the cable as tight as possible and tighten the cable clamps. With a spanner tighten up the adjuster nut to tension the cable and make good the seal.

Note: - After fitting neatly coil up the excess cable. Do not cut off the excess cable.

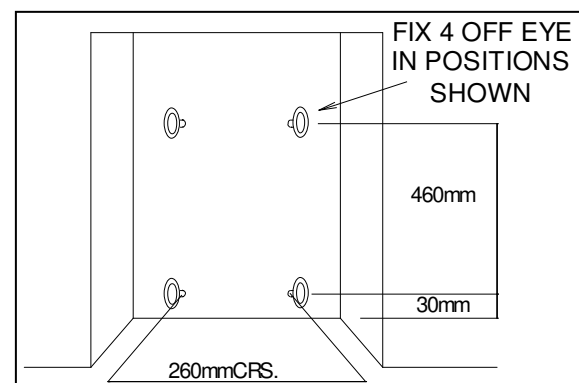
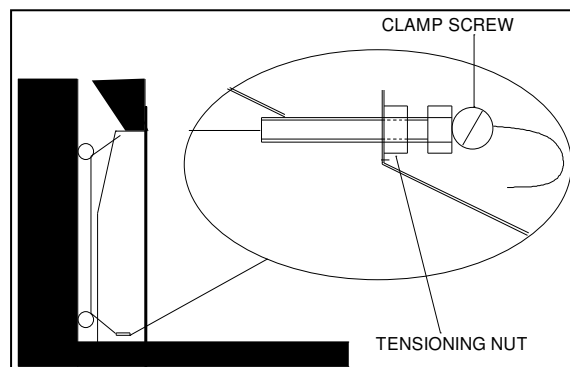

CHECKING GAS SOUNDNESS

- Turn on the gas supply to the appliance and check for soundness in accordance with current codes of practice.
- Turn off the gas supply at the external Isolation valve.
- Remove the pressure test point screw from the inlet elbow and connect the pressure gauge.
- Turn on the gas to the appliance at the Isolation valve.
- Rotating the control to the ignition position and push in to allow the air in the pipe to be purged.
- Rotating the control knob a few times, check that the electrode is sparking at the gap between the thermocouple tip and the electrode; continue until pilot ignition is established.
- Depress the control knob slightly and rotate anticlockwise until it is aligned with the large flame symbol on the control panel.
- Check the inlet pressure is 20mbar. +/- 1.0.
- Turn off gas supply, at the isolation valve. Disconnect the pressure gauge and replace the pressure test point screw.
- Turn on the supply to the appliance and check the pressure test point for soundness with detection fluid.

COAL BED LAYOUT

Important: - Refer to the Health & Safety Notice located on page 5 of this booklet before laying or replacing any refractory material.

Note : In the event of replacing coals please use only the specified number of coals as illustrated – Use coal provided for this fire only. In the interest of safety and efficiency of your appliance when replacing coals it is essential that the existing coals are removed and the new coals are replaced correctly as a complete set.

It is important that all the coals and moulded shapes are positioned as shown in these instructions.

IF THE COALS ARE NOT POSITIONED CORRECTLY THIS MAY RESULT IN DAMAGE TO THE GLASS.

LAY COALS AS SHOWN IN SECTION THREE.

[SECTION TEN Checking Operation of Fire \(installation instructions\)](#)

CHECKING FOR COMBUSTION PRODUCTS CLEARANCE

IMPORTANT:-The smoke test must be carried out with the fire starting from cold.

- Light the fire and leave at maximum input.
- Close all the doors and windows.
- After five minutes fit the smoke match in a holder and position as illustrated with the head of the match just inside the test opening.
- Run the match along the top edge **All smoke** must be drawn into the test opening if the clearance is satisfactory.
- If spillage occurs wait a further five minutes and repeat the test.
- Repeat the test with doors open and with any extractor fans in other rooms in operation.

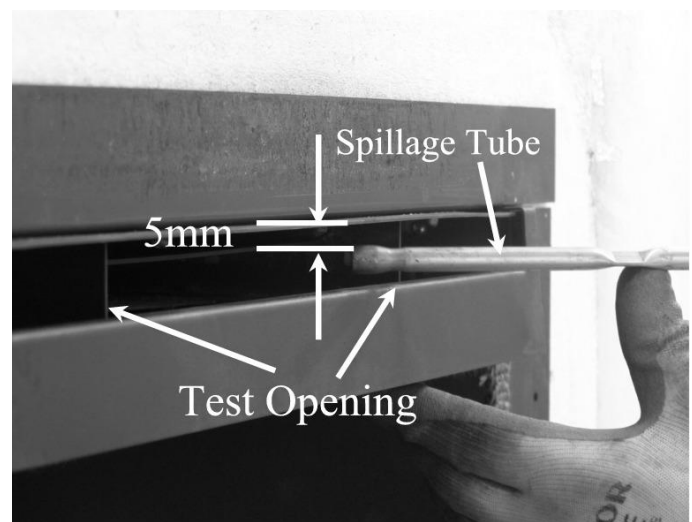

THE FIRE FRET AND DECORATIVE TRIM

FIT FIRE TRIM AND FRET

- Fit the fire with the magnetic strips placed on the vertical side flange of the box.
- Offer the decorative trim up squarely and centrally and push into position.
- To remove the decorative trim, simply pull away from the magnetic strips.
- Fit the fire fret by standing on the hearth in front of the fire. Removal is the reverse of this operation.

ADVISE CUSTOMER THAT:

- The glass front of this fire acts as a dress guard, conforming to BS 1945 (1997) and satisfies the heating appliance regulations (1991) however; a fireguard conforming to BS6539 (1997) must be used to protect young children, the elderly or infirm.
- The curing effect of heating the coals and other refractory components will cause an initial odour. This is due to the starch used in the manufacturing process and is non-toxic.
- The fret is hand cast and some minor imperfections may be found on the surface.
- Any debris should be cleaned from the appliance. A vacuum cleaner can be used but only after all the loose coals have been removed. The appliance should be serviced annually by a competent person in accordance with these instructions, the flue checked, and the appliance checked for spillage in accordance with the method detailed in these instructions.
- Demonstrate the lighting and extinguishing procedures to the user and the removal and refitting of the brass trim fret and glass panel for cleaning. Refer to the user section of this booklet.

Hand these instructions over to the user.

SECTION ELEVEN Maintenance (maintenance instructions)

GENERAL

- Servicing should be carried out annually by a competent person such as a GAS SAFE registered person in accordance with the relevant regulations, to ensure the safe and correct operation of the appliance.
- Before commencing any service or replacement of parts, turn off the gas supply to the fire. After servicing check for gas soundness.
- When ordering spare parts please quote appliance name and serial number, these can be found on the data badge, which is located behind the fret on the right hand side of the appliance.
- At least once a years check for debris in the catchment area behind the fire and in the flue way.
- If soot has accumulated checks to establish cause rectify and clean flue or chimney accordingly.

PILOT LINTING

Check pilot aeration holes for linting, use a vacuum cleaner nozzle taking care not to damage the pilot head.

FUEL BED CLEANING

Important: - Refer to the Health & Safety Notice located on page 5 of this booklet before cleaning or replacing any refractory material.

The fuel bed components are delicate and they should be handled with great care.

The loose parts and moulded shapes may be removed for cleaning. They can be brushed very gently with a soft brush to remove dust or any deposits. A vacuum cleaner may only be used after the loose components have been removed.

Examine the fuel bed components for signs of cracking and replace if necessary. (IMPORTANT) see fuel bed layout procedure before attempting to replace loose fuel bed components, which should only be replaced as a complete set with no extra components being added.

REPLACEMENT OF GAS CONTROL TAP

1. Turn off the gas supply by isolating cock.
2. Lift away carefully fire fret.
3. Remove the trim and glass panel (see Section Nine).
4. Lift away carefully all loose fuel bed components.
5. Lift away carefully rear matrix.
6. Remove plastic knob from gas control tap.
7. Remove burner secured with two screws and remove refractory side panels.
8. Undo and remove bottom two screws from bezel plate located at the front of the appliance.
9. Disconnect gas supply from inlet elbow of appliance (right of gas control tap)
10. Remove two screws securing the burner tray to the appliance and lift out tray.
11. Disconnect the three compression gas connections from the gas control tap.
12. Remove the ignition lead carefully from the ignitor on the gas control tap.
13. Undo the thermocouple connection from the rear of the gas control tap.
14. Undo and remove the two screws securing the gas control tap to assembly.
15. Service or replace gas control tap as necessary.
16. Re-assemble the in reverse order.
17. Turn on the gas supply, check for soundness and re commission appliance.

REPLACEMENT OF BURNER AND OR THE SILENCER

NOTE: The silencer must not be modified and must be correctly positioned in its bracket (i.e. open end facing injector).

1. Turn off the gas supply by isolating cock.
2. Carefully lift away fire fret.
3. Remove the trim (secured with magnets) and glass panel (see Section Nine).
4. Lift away carefully all loose fuel bed components.
5. Lift away carefully rear matrix.
6. Remove burner secured with two screws.
7. Clean, service or replace as necessary.
8. Re-assemble in reverse order.
9. Turn on gas supply, check for gas soundness and recommission appliance.

REPLACEMENT OF INJECTOR

1. Remove burner tray (1-10 of Replacement Gas Control Tap).
2. Undo the compression nut on the supply pipe to the injector.
3. Remove the silencer pad carefully
4. Unscrew the locking nut holding the injector(s) on the chassis.
5. Clean or replace the injector(s). NOTE: -Do not use wire or a drill to clean out holes.
6. Re-assemble in reverse order.
7. Turn on gas supply, check for gas soundness and recommission appliance.

REPLACEMENT OF OXY-PILOT ASSEMBLY

NOTE: If the pilot assembly is replaced it must be replaced by an identical unit from the same manufacturer and replaced as a complete unit.

1. Remove burner tray (1-10 of Replacement Gas Control Tap).
2. Carefully pull off the ignition lead.
3. Disconnect the thermocouple at the end of the main control valve.
4. Remove the screws holding the pilot to the chassis
5. Carefully remove the oxy-pilot.
6. Remove burner tray (1-10 of Replacement Gas Control Tap).
7. Re-assemble in reverse order.

Register your appliance online today to active your warranty



GAS FIRE COMMISSIONING CHECKLIST

This Commissioning Checklist is to be completed in full by the competent person who commissioned the gas fire as a means of demonstrating compliance with the appropriate Building Regulations and then handed to the customer to keep for future reference.

Failure to install and commission according to the manufacturer's instructions and complete this Benchmark Commissioning Checklist will invalidate the warranty. This does not affect the customer's statutory rights.

Site Requirements	Yes	N/A
Was the chimney checked to ensure it only serves one flue/fire, has no obstructions and is continuous?		
Has any debris at the base of the chimney been removed?		
For brick chimney installations is there enough depth for 12 litres of debris, or precast flues 2 litres of debris? (see instructions for debris gap details)		
Have damper and register plates been removed or locked in the fully open position ensuring correct size of flue is maintained?		
If previously used for solid fuel has the chimney been thoroughly swept?		
If the chimney is pre-cast has the inside of the flue been checked for extruded cement / sealant which must be removed?		
Has the fire place been checked for under-floor air supply which must be sealed off?		
Has the chimney been inspected prior to fitting the gas fire to ensure that it is in good condition?		
Has the structure of the chimney been checked for leakage using a smoke pellet test? (See BS5440-1 for details).		
Ventilation		
Does the installation require any additional ventilation requirements as detailed in the manufacturer's instructions?		
Hearth Requirements- where fitted		
Is the hearth constructed from non -combustible material?		
Is the hearth a minimum of 12mm thick with a minimum floor to top surface of 50mm?(BS5871) or as per manufacturer's instructions?		
Is the hearth for open fronted fires a minimum of 760mm wide and has 300mm projecting from the fire opening (BS6871) or to manufacturer's instructions?		
Mounting height (where applicable) has the fire been installed to the correct mounting height- as per manufacturer's instructions?		
Firebox and Fuel Bed		
Has the fuel bed, coals, pebbles etc. been fitted to manufacturer's instructions?		
Gas Supply		
Has an isolation tap/restrictor inlet elbow been fitted for servicing?		
Has the gas supply been thoroughly purged prior to connection to remove any debris?		
Has a gas tightness test been completed prior to breaking into the gas supply and following completion of installation?(IGEM/UP/1B)		
Record burner gas pressure reading? If only the supply pressure is available a gas rate must be undertaken.(GSIUR REG26/9C)		
Record dynamic inlet gas pressure (working pressure) reading (all gas appliances running)		
Spillage test		
Installation passes smoke match test with any extractor fans turned on (see manufacturer's instructions)		
Installation		
Has the gas fire been installed and commissioned in accordance with manufacturer's instructions?		
Has the fire been installed with the correct clearance to combustible materials, as per manufacturer's instructions?		
The operation of the appliance and controls have been demonstrated to the customer including battery replacement where applicable?		
The manufacturer's literature, including Benchmark Checklist and Service record has been explained and left with the customer?		
Has the appliance been registered with the Local Authority as detailed on the Gas Safe web site and is a legal requirement and forms part of the warranty?		
Customer's Signature: (To confirm satisfactory demonstration and receipt of manufacturer's literature)	Commissioning Engineer's Signature:	

*All installations in England and Wales must be notified to be Local Authority Building Control (LABC) either directly or through a Competent Persons Scheme. A Building Regulations Compliance Certificate will then be issued to the customer.

SERVICE RECORD

It is essential that your gas fire is serviced regularly and that the appropriate Service Interval Record is completed. Service Provider

Before completing the appropriate Service Record below, please ensure you have carried out the service as described in the manufacturer's instructions. Always use the manufacturer's specified spare part when replacing controls.

SERVICE 01	Date:
Engineer name:	
Company name:	
Telephone No:	
Gas safe register No:	
Comments:	
Signature	

SERVICE 02	Date:
Engineer name:	
Company name:	
Telephone No:	
Gas safe register No:	
Comments:	
Signature	

SERVICE 03	Date:
Engineer name:	
Company name:	
Telephone No:	
Gas safe register No:	
Comments:	
Signature	

SERVICE 04	Date:
Engineer name:	
Company name:	
Telephone No:	
Gas safe register No:	
Comments:	
Signature	

SERVICE 05	Date:
Engineer name:	
Company name:	
Telephone No:	
Gas safe register No:	
Comments:	
Signature	

Focus HE Slimline Coal

Product ID Label	A-0134	Serial No Prefix	KM
Fire Box Labels Spillage (1057) Data Badge			
Fire Box Grommet			
Burner Tray / Box Assembly			
Warning Label (Fire Guard)			
Coal Set 5322			
Rear Matrix 5319			
Front Matrix 5320			
7mm Nut Spinner (5435)			
Glass Panel			
Canopy			
Segment Magnets 3048			
Fixing (A-0474) (includes 4 magnets)			
Seal (4904)			
Owners Book			
ID Label & Packing Label			
Serial Number			
Inspector			

Focus HE Slimline Pebble

Product ID Label	A-0135	Serial No Prefix	KM
Fire Box Labels Spillage (1057) Data Badge			
Fire Box Grommet			
Burner Tray / Box Assembly			
Warning Label (Fire Guard)			
Pebble Set 5323			
Rear Matrix 5319			
Front Matrix 5321			
7mm Nut Spinner (5435)			
Glass Panel			
Canopy			
Segment Magnets 3048			
Fixing (A-0474) (includes 4 magnets)			
Seal (4904)			
Owners Book			
ID Label & Packing Label			
Serial Number			
Inspector			