

Owner's Manual

INCLUDES

User, Maintenance, Service, and Installation
Instructions

firelineTM

FXW / FPW FREESTANDING GAS STOVE RANGE



Keep this booklet for service log and future reference

IMPORTANT



This appliance is guaranteed for 12 months subject to conditions. The 5 year extended parts warranty will only be valid if the annual service recommended in this manual has been completed and appliance has been registered online.

For use in Great Britain and Ireland.

Literature NO 6498 (ISS 2)

Contents

EXTENDED FIVE YEAR PARTS WARRANTY	2
Benchmark Scheme	3
SECTION ONE Introduction (Users Instructions)	5
SECTION TWO Operating the Appliance (Users Instructions).....	7
SECTION THREE Cleaning (Users Instructions)	8
SECTION FOUR Fuel Bed Cleaning and Layout (Users Instructions).....	9
SECTION FIVE General Points (Users Instructions)...	14
SECTION SIX Appliance Data (Installation Instructions).....	15
SECTION SEVEN Regulations and Warnings (Installation Instructions).....	17
SECTION EIGHT Siting the Appliance (Installation Instructions).....	19
SECTION NINE To Install the Appliance (Installation Instructions).....	22
SECTION TEN Checking Operation of Fire (Installation Instructions).....	23
SECTION ELEVEN Maintenance (Maintenance Instructions).....	25
SECTION TWELVE Short Spare's List	27
GAS FIRE COMMISSIONING CHECKLIST.....	30
SERVICE RECORD.....	31



EXTENDED FIVE YEAR PARTS WARRANTY

In order to validate your extended 5 years parts warranty please read the Benchmark Scheme on the opposite page and ensure your installer has filled in the appropriate checklist.

This in no way reduces your statutory rights

Your warranty commences from the date of purchase and you must retain your receipt or invoice as proof of a purchase date.

THIS EXTENDED WARRANTY SPECIFICALLY EXCLUDES GLASS AND SOFT REFRACTORY COMPONENTS, THE BULB AND ANY BATTERIES.

Terms and Conditions

1. The appliance must be installed by a GAS SAFE registered person.
2. The appliance must be used in accordance with the user's instructions.
3. The appliance must be serviced annually by a GAS SAFE registered person.
4. The benchmark and service log must be correctly filled out and the record of annual services must be up to date and supported by receipts in each case.
5. This warranty is not transferable and relates to the original installation only.
6. The appliance has not been subjected to misuse or accident or been modified or repaired by any person other than the authorised employee or authorised representative of Charlton and Jenrick Ltd.
7. The registration form must be returned within 1 month of purchase.

Technical Help Desk 01952 200 444

Benchmark Scheme



Charlton and Jenrick Ltd is a licensed member of the Benchmark Scheme which aims to improve the standards of installation and commissioning of domestic heating and hot water systems in the UK and to encourage regular servicing to optimise safety, efficiency and performance. Benchmark is managed and promoted by the Heating and Hotwater Industry Council. For more information and the full code of practice please visit www.centralheating.co.uk

Please ensure that the installer has fully completed the Benchmark Checklist on the inside back pages of the installation instructions supplied with the product and that you have signed it to say that you have received a full and clear explanation of its operation. The installer is legally required to complete a commissioning checklist as a means of complying with the appropriate Building Regulations (England and Wales).

All installations must be notified to Local Area Building Control either directly or through a Competent Persons Scheme. A Building Regulations Compliance Certificate will then be issued to the customer who should, on receipt, write the Notification Number on the Benchmark Checklist.

This product should be serviced regularly to optimise its safety, efficiency and performance. The service engineer should complete the relevant Service Record on the Benchmark Checklist after each service.

The Benchmark Checklist will be required in the event of any warranty.

It is a requirement that the gas fire is installed and commissioned to the manufacturer's instructions and the data fields on the commissioning checklist completed in full.

To instigate the guarantee, the gas fire needs to be registered with the manufacturer within one month of the installation.

To maintain the guarantee, it is essential that the gas fire is serviced annually by a Gas Safe registered engineer. The service details should be recorded on the Benchmark Service Interval Record and left with the householder.

Important

For future reference we suggest you record the following details here, and keep the receipt as proof of purchase. This information may be asked for when you contact the helpdesk.

MODEL:	FXW / FPW FREESTANDING GAS STOVE	Serial No.	
---------------	---	-----------------------	--

This information can be found on the label attached to the packaging and on the data badge, which is located on the base of the appliance behind the control cover.

Retailer Name:	
Address:	
Date Of Purchase:	

Important: – These products must be installed by a suitably qualified Installer.

Important: - The Allen Bolt must be removed from the Left Hand side of the Stove, before attempting to open the door, to avoid damage to the Handle mechanism.

Important: - The Stand off brackets must be attached to the bottom rear of the Stove prior to installing.

Installer information required to register for the extended warranty

Name:	
Date of installation:	
Gas safe number:	

SECTION ONE Introduction (Users Instructions)

Consumer Protection Information

As manufacturers and suppliers of heating products, we take every care, as far as is reasonably practicable, that these products are so designed and constructed as to meet the general safety requirement when properly used and installed. To this end, our products are thoroughly tested and examined before despatch.

IMPORTANT NOTICE: Any alteration that is not approved by the appliance manufacturer could invalidate the approval of the appliance, operation of the warranty and could affect your statutory rights.

Health and Safety Notice

Important

This appliance could contain some of the materials, indicated below, that could be interpreted as being injurious to health and safety. It is the users / installers responsibility to ensure that the necessary personal protective clothing is worn when handling these materials, see below for information.

Artificial Fuels, Mineral Wool, Insulation Material, Refractory/Ceramic Fibres, Glass Yarn - *may be harmful if inhaled, may be irritating to skin, eyes, nose and throat.*

When handling *avoid inhaling and contact with skin or eyes. Use disposable gloves, facemasks and eye protection. After handling wash hands and other exposed parts. If a vacuum is used for cleaning the Logs or cleaning after servicing / installation it is recommended that it be of the type fitted with a HEPA filter.*

Disposal of refractory/ceramic materials. To keep dust to a minimum these materials should be securely wrapped in polythene and be clearly labelled 'RCF waste'. These materials are not classified as 'hazardous waste and should be disposed of at a site licensed for the disposal of industrial waste.

Introduction

- The FIRELINE FXW/FPW has been designed and tested for use in GB (Great Britain) and IE (Ireland).
- The FIRELINE FXW/FPW incorporates a single gas control, which selects ignition pilot, and main burner low and high settings.
- The FIRELINE FXW/FPW incorporates a safety device in the form of an Oxygen Depletion System, which constantly monitors the oxygen in the room and will cause the fire to switch off if the oxygen level reduces, for instance due to insufficient ventilation or a blocked flue.
- If this regularly occurs do not attempt to relight the appliance until a qualified engineer has checked it, the problem may not be due to lack of air or a defective flue.

Important Information !

- When installing the FIRELINE FXW/FPW Gas Stove, careful consideration should be made to the siting of the appliance as a spillage test will need to be carried out at the Draught Diverter at the rear of the stove.
- When siting into an Inglenook, consideration should be made for access to the rear of the appliance, either from to top or sides of the stove so a spillage test can be witnessed. A small mirror may be required.

- A minimum of 45mm needs to be left between the rear of the stove and the closure plate (with standoff brackets fitted) or back wall for correct operation of the stove

Important Information

- The appliance is for use on Natural Gas (G20 @ 20mbar) or Propane (G31 @ 37mbar) Only.
- The chimney or flue (unless new or previously used with a gas appliance) shall be swept before installation if it has been used for solid fuel.
- Failure to install appliance correctly could lead to prosecution.

In GB (Great Britain), the appliance must be installed by a competent person i.e. GAS SAFE registered, in accordance with the GAS SAFETY (INSTALLATION AND USE) REGULATIONS, The Building Regulations (or The Building Regulations (Scotland) or The Building Regulations (Northern Ireland)) and The Current I.E.E. Wiring Regulations, if appropriate.

In IE (Ireland), the appliance must be installed by a competent person and installed in accordance with the current edition of I.S.813 Domestic Gas Installation, the current Building Regulations and the current ETCl rules for electrical installation, if appropriate.







- The glass front of this fire acts as a dress guard, conforming to BS 1945 (1997) however; a fireguard conforming to BS6539 (1997) must be used to protect young children, the elderly or infirm.
- The appliance MUST NOT be used with the glass safety screen removed or if it is damaged or cracked.
- During initial firing, an odour may be evident. This is the starch binder used during the manufacture of the fibre components of the fire, and there are **no harmful** effects produced.
- During the normal operation of the fire some black staining may appear on some parts of the fuel bed. This is quite normal and adds to the appearance of the appliance. However, if excessive black staining does occur it may be due to the fuel bed being incorrectly laid. This should be checked prior to contacting a service engineer.
- Care must be taken to prevent any damage being caused to surrounding soft furnishing or decoration; e.g. many embossed vinyl wall coverings may become discoloured if placed too close to the appliance. Combustible material i.e. wall panelling or wallpaper must be removed from behind the fire.
- It is advised that this appliance is serviced annually; as it is more likely to provide trouble-free operation.
- In GB (Great Britain) the fire does not normally require purpose built ventilation, but if for any special reason purpose built ventilation is provided it should be checked periodically to ensure freedom from obstructions.
- In IE (Ireland) permanent ventilation must comply with the current edition of IS813.

Distances from NON-combustible materials:

- The stove can be recessed in a suitable sized non-combustible fireplace but a permanent free air gap of at least 50mm must be left around the sides and top and at least 45mm at the back of the stove to obtain reasonable heat output and for access to the stove for removal and maintenance. A clearance of 150mm will give a better heat output
- When installing the FIRELINE FXW/FPW Gas Stove, careful consideration should be made to the siting of the appliance as a spillage test will need to be carried out at the Draught Diverter at the rear of the stove.
- When siting into an Inglenook, consideration should be made for access to the rear of the appliance, either from the top or sides of the stove so a spillage test can be witnessed. A small mirror may be required. **PLEASE CHECK BEFORE INSTALLING.**
- A minimum of 45mm needs to be left between the rear of the stove (with standoff brackets fitted) and the closure plate or back wall for correct operation of the stove.

SECTION TWO Operating the Appliance (Users Instructions)

The full lighting procedure is as follows: -

1. The Gas Control Knob protrudes through the bottom of the front door.
2. Push knob in as far as possible on gas control.
3. Turn knob anti-clockwise until a click is heard. The knob will stop at the position marked  and a spark should be seen at the tip of the ignition probe. At the same time the pilot flame should light. KEEP THE KNOB PRESSED IN FOR 20 SECONDS. Should the pilot fail to light, turn the control knob clockwise to the  position, wait 3 minutes, and repeat the procedure.
4. After lighting the pilot flame the control knob should be allowed to spring out slightly. This will allow you to turn the knob further anti-clockwise to the position marked . The pilot flame should then ignite the main fire.
5. It is possible to adjust the height of the flames by turning the control knob between the positions marked  and . Note that the knob 'latches' in position at either end of this movement and must be pushed in slightly before it can be turned.
6. To turn the fire off, depress the knob slightly and turn it to the  position.
7. To completely extinguish the fire, depress the knob slightly and turn to  the position.

Important Information !!!

- If the fire goes out for any reason, or it is turned off and is to be turned on again, it is necessary to wait three minutes before attempting to re-light.
- **The spillage monitoring system will operate if the flue does not work or becomes blocked.**
- **If the fire repeatedly goes out during use, this may be due to lack of ventilation or a blocked flue. Expert advice should be obtained.**
- **Do not use the fire with the glass safety screen removed, or if the glass is cracked.**

Important Information !!!

- The Allen Bolt must be removed from the Left Hand side of the Stove , before attempting to open the Door, to avoid damage to the Handle Mechanism.

SECTION THREE Cleaning (Users Instructions)

Warning: -

Before you clean any part of the appliance ensures that the appliance is turned off and cold.

Cleaning: Black Painted Surfaces

- These surfaces should be dusted regularly and any marks removed with a soft cloth.
- Abrasive or chemical cleaner should **never** be used.

Cleaning: Pilot Assembly

(Before cleaning ensure that the appliance is turned off and cold)

In some instances you may experience ignition problems even when the appliance is new. This may be due to the aeration hole in the pilot body (see photograph) being partial blocked with dust, pet hairs, or other foreign matter. The source of this debris could be such things as carpet fibres, decorating dust or pet hairs etc.

To gain access to the pilot remove the Gas Control Knob by loosening the two retaining screws, remove the Allen Screw on the Door handle and open the door. The Log Fuel Bed will need to be removed for access around the pilot.

The pilot is located on the left hand side of the appliance, any debris in or around the aeration hole can usually be removed using the nozzle of a vacuum cleaner around the top of the pilot assembly, this usually draws it out of the aeration hole. It is advisable not to blow the debris into the hole or pilot assembly as this may cause more of a restriction and not rectify the problem.

Note: - Take care when cleaning in this area so as not to damage the pilot assembly.

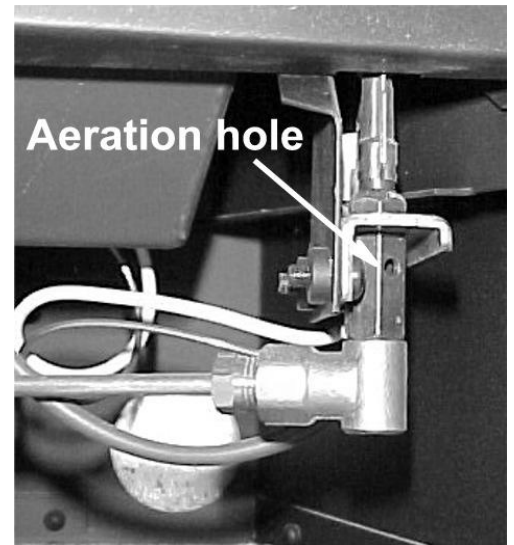

Glass Cleaning

From time to time it will be necessary to clean the glass panel of your Fireline FXW/FPW Gas Stove. We recommend you use a Ceramic hob cleaner these are available for all leading super markets: - i.e. ASDA, TESCO, SAINSBURY'S Etc.

Brands of hob cleaning we have tested and found suitable are - **HOB BRITE & VITRO CLEN.**

- Ensure the fire as been turned OFF for at least four hours to ensure it is cool.
- Remove the Gas Control Knob by loosening the two retaining screws and slide off the valve spindle, remove the screws holding the door closed and open the door.
- The door can either be cleaned while attached to the stove or taken off by removing the two door hinge pins and lifting the door upwards taking care as the door is made from cast iron and is heavy.
- Lay some old newspaper under the area you are working on when the door is open.
- Follow the instructions on the Hob Cleaner Bottle.
- On stubborn stains (where the appliance as been used for a long period without glass panel being cleaned), use a new Brillo Pad well wetted with the Hob cleaner applied directly to it.
- Ensure all the residues of the cleaner are removed with a damp cloth and the glass panel is completely dry before closing/rehanging the door and refastening the door to the stove.

Important: - The appliance must not be used if the glass panel is missing or damaged.

Note: - The glass may discolour quickly when first installed, and it should be cleaned. This is due to the burning off process of the refractory shapes.

REMOVING GLASS PANEL

- Remove the Gas Control Knob by removing the two retaining screws on the rear of the knob, it may be necessary to turn the knob to gain access to the screws (Isolate Gas supply for safety).
- Remove the Allen screw that fastens the door back to the stove and open.
- Loosen the two lower screws on the lower glass fixing clamp, but do not remove clamp.
- Remove the top glass fixing clamp secured with two screws, take care to support the glass panel when removing the fixing clamp. Lift the glass out of the bottom clamp.
- The glass should be placed in a safe place to prevent damage.
- Once the fuel bed has been re-laid, reassemble in reverse order.

SECTION FOUR Fuel Bed Cleaning and Layout (Users Instructions)**Warning: -**

- Before you clean any part of the appliance ensure that the appliance is turned off and cold.
- Use only the fuel bed components provided and no additional parts must be added.
- Incorrect positioning of the fuel bed components could result in the staining of the glass panel.

Important: - Refer to the 'Health & Safety Notice located on page 5 of this booklet before cleaning or replacing any refractory material.

- The fuel bed components are delicate and they should be handled with great care.
- The loose Log shapes may be removed for cleaning. They can be brushed very gently with a soft brush to remove dust or any deposits.
- A vacuum cleaner may only be used after the loose Log shapes and vermiculite has been removed.

CARE SHOULD BE TAKEN TO AVOID DAMAGE TO THE LOG SHAPES AS THESE ARE A DELICATE SURFACE AND SHOULD **NOT** BE WIPED OR RUBBED.

It is important that all the Log Fuel Bed shapes are positioned as shown in these instructions.

Log Fuel Bed Quantities.

Six Log Shapes :-

- Two rear Log shapes with cutouts at the back of the shapes.
- Four main Log shapes.

Bag of Bark Chips & Bag of Vermiculite.

Log Fuel Bed Layout

- Place a thin layer of vermiculite over the stainless steel burner, making sure not to cover or block the pilot assembly on the left hand side



- Before laying the rear shapes, make sure that the cut out's in the shapes are at the rear as shown in the picture.

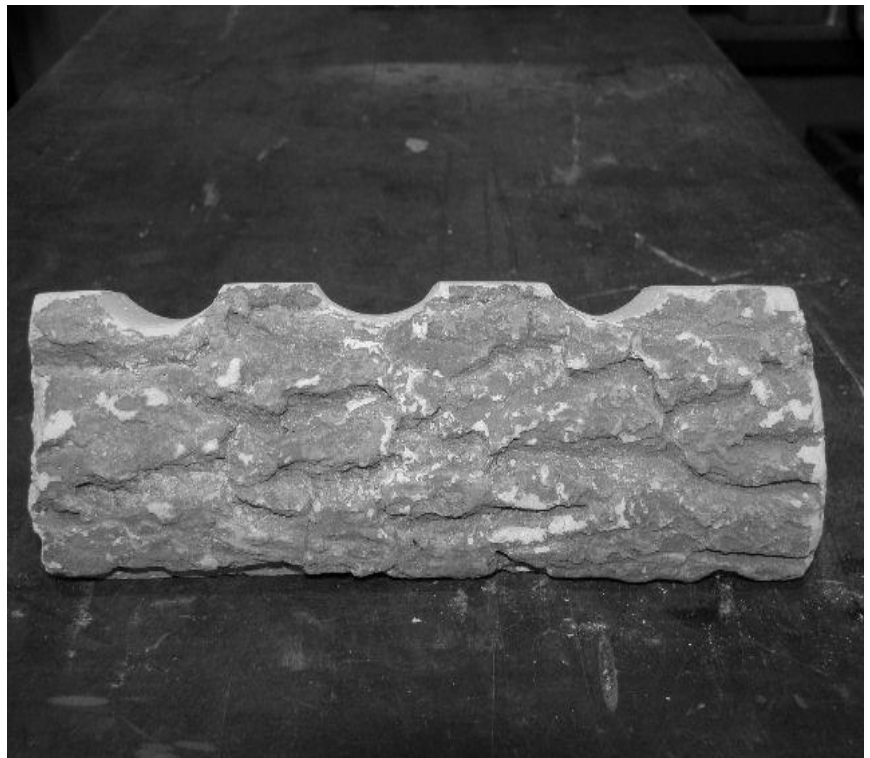

- Place the LH1 (shorter log) and RH2 (longer log) Rear Log shapes at the back of the Air Tray with the cut outs at the back and the Bark effect at the Top so they lie on the pointed edge.
- Position the shapes so the bottom “V” of the shapes are between the first row of Air Holes and the second row of Air holes behind the burner bar.



- Place a single layer of Bark Chips in front of the Burner Bar making sure not to cover or obstruct the Pilot assembly or rest too far onto the Burner Bar.



- Place the first Log Shape (3) as far to the right and back as possible, resting on the rear shape and resting on top of the Bark Chips as shown in the picture.



- Place the second Log Shape (4) next to the first shape so it touches at the front right hand side and leaves a gap between the first shape at the rear.
- Make sure not to disturb the Bark Chips.



- Place the third Log Shape (5) so that it sits on it`s edge and sits between the two back shapes as shown.



- Place the last Log Shape (6) as so that is as far back and to the left as possible at the rear, and as far to the right at the front so it touches the third log shape.
- Make sure all the shapes are touching at the front and that they are evenly spaced at the rear, as shown in the picture; this will produce the best flame picture.



- The door can now be closed and safely fastened using the Allen Screw at the side making sure the seal around the door is in the correct position.
- The Gas Control knob can now be fastened using the two screws of the rear of the knob, it may be necessary to turn the Knob to gain access. (Isolate the Gas supply for safety).
- Make a note of the “D” shape on the valve spindle and the cut out on the Gas Control knob.



SECTION FIVE General Points (Users Instructions)

Like all appliances incorporating an aerated burner a low frequency noise may be heard, particularly on the low setting, this is quite normal and does not affect the operation of the appliance.

It is advised that a competent person service the Fireline FXW/FPW fire annually. The fire is more likely to provide trouble-free operation.

Dulling and slight discoloration inside the firebox will occur adding to the realism of the appliance. This is normal.

It is important that: -

- The chimney or flue is checked annually to ensure clearance of combustion products.
- The fire must never be operated with the door open.
- Any debris from the chimney or flue should be removed. The fire should be allowed to cool before it is removed.
- The fire must not be used if the glass panel is missing or damaged.
- The data badge is located on the appliance base.

The only user removable parts are: -

- Refractory Fire bed Components.
- Glass panel.

SECTION SIX Appliance Data (Installation Instructions)

	NATURAL GAS	PROPANE
Gas Type:.....	CATEGORY I 2 H	CATEGORY I 3 P
Gas Pressure:.....	20 mbar +/- 1.0mbar	37mbar +/- 1.0mbar
Pressure Test Point Location:.....	Gas inlet elbow	
Gas Input:.....	5.5 kW Gross (Max.)	5.0kW Gross.(Max.)
	2.4 kW Gross (Min.)	2.4kW Gross.(Min.)
Injectors:.....	Mk 360	Mk 116
Oxy pilot:.....	9044 N.G./ 2550 N.G.	9222 L.P.G.
Gas Connection:.....	8mm compression: semi-rigid or rigid	

Data Badge located on inside of door or on plate attached to the rear of stove.

Appliance Dimensions :-

FXW/FPW STOVE DIMENTIONS

STOVE SHOWN AS TOP EXIT

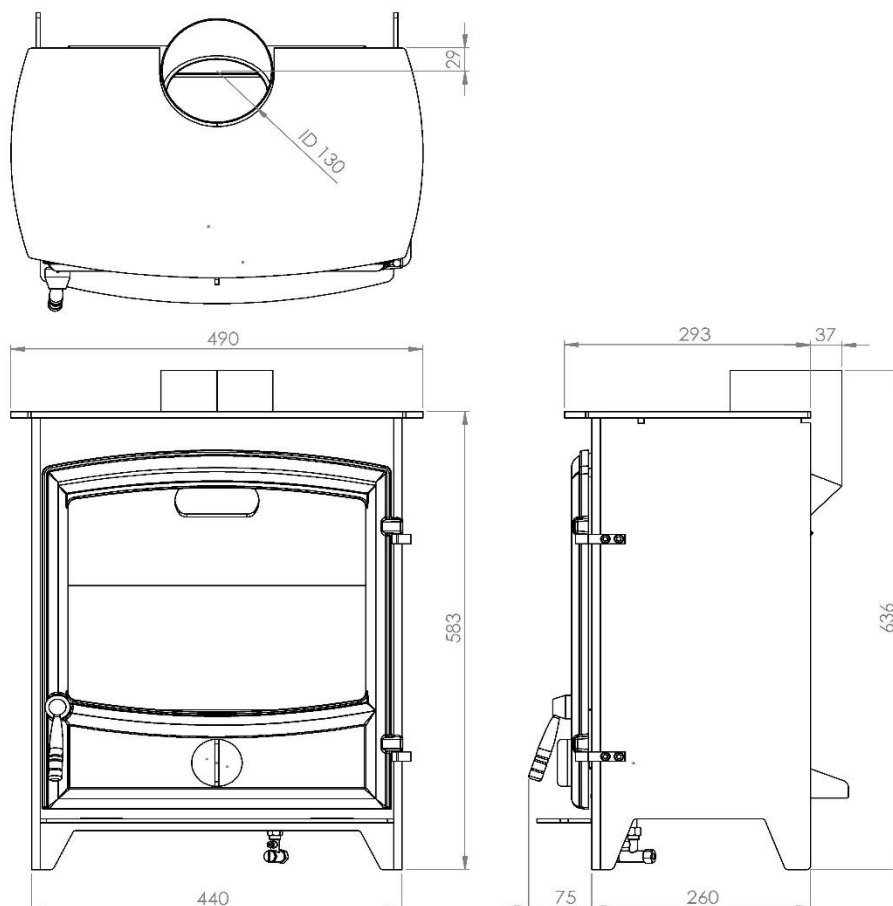

FXW/FPW STOVE DIMENSIONS

STOVE SHOWN AS REAR EXIT

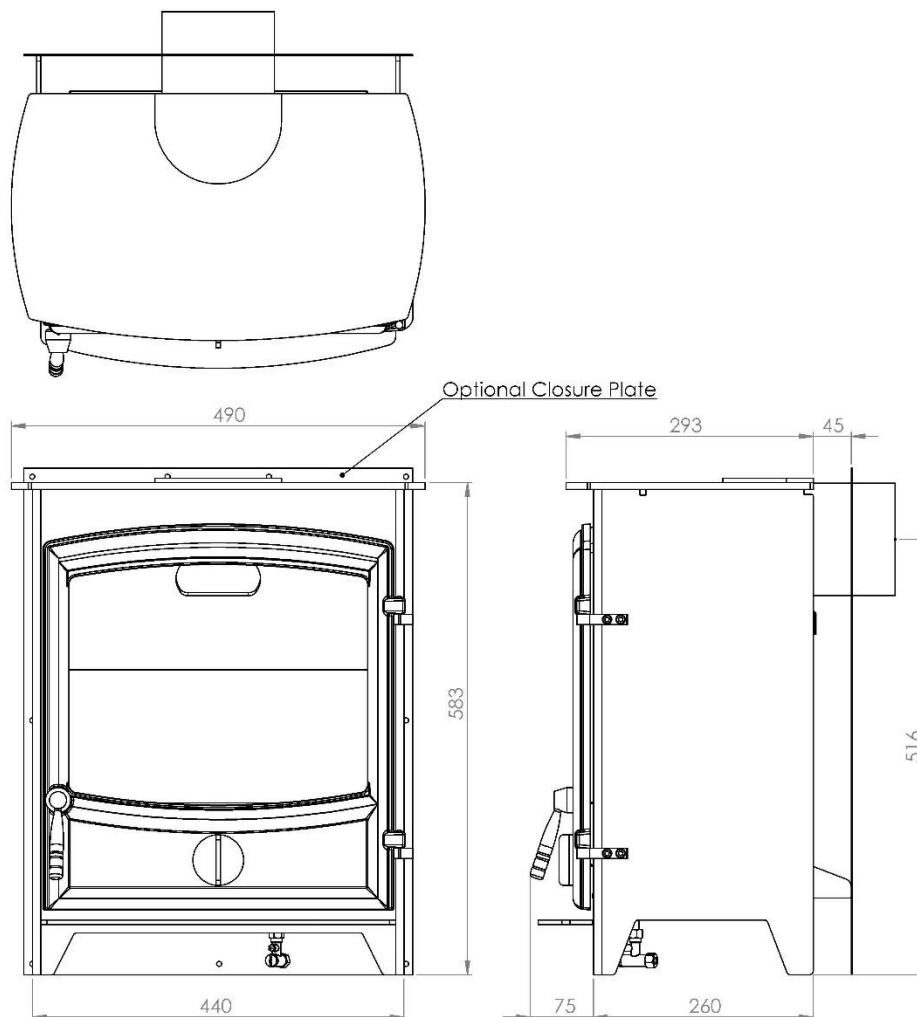

N.B. - Rear Stand off brackets must be attached prior to installing !

Data Badge located on inside of door or on plate attached to the rear of stove.

NOTE: The efficiency of this appliance has been measured as specified in BS EN 613:2001 and the result is 70.3%. The gross calorific value of the fuel has been used for this efficiency calculation. GasTec have certified the test data from which it has been calculated. The efficiency value may be used in the UK Government's Standard Assessment Procedure (SAP) for energy rating of dwellings.

When unpacking the appliance please check the following items are included:

Fuel Bed: 6 piece Log fuel bed, Vermiculite & Bark Chips.

Closure Plate.

Owners Manual.

Fixing Kit (including :- Restrictor Elbow / Stand off Brackets /2 x Allen keys & bolts.)

Flue Spigot / Gasket/handle /fixing screws and bolts and the blanking plate (semi-circle plate)

SECTION SEVEN Regulations and Warnings (Installation Instructions)

- This appliance must only be installed in Great Britain or Ireland.
- The appliance is suitable for use on natural gas and propane
- **GB (Great Britain)** This fire does not normally require purpose build ventilation.
- **IE (Ireland)** Permanent ventilation must comply with the current edition of IS813.
- **In GB, (Great Britain)**

It is the law that all gas appliances must be installed by a competent person; i.e. a GAS SAFE registered installer, in accordance with the Current Gas Safety (Installation And Use) Regulations (as amended), all relevant parts of the local and national building regulations and all relevant recommendations of the following British Standards. Failure to do so could lead to prosecution.

The following are relevant codes of practice and British Standards: -

B.S. 5871

B.S. 5440 PART 1 & PART 2

B.S. 6891

This appliance must be installed to current versions of the above standards and include any relevant amendments to:-

The Building Regulations Issued By The Department Of The Environment.

The Building Standards (Scotland) (Consolidated) Regulations Issued By The Scottish Development Office.

- **IN IE, (Ireland)**

The appliance must be installed by a competent person and installed in accordance with the current edition of I.S.813 Domestic Gas Installation, the current building regulations, and the current ETCI rules for electrical installation, if appropriate.

- Prior to the installation ensure that the local distribution conditions (identification of type of gas and pressure) and adjustment of the appliance are compatible. Natural gas (G20 @ 20mbr)or(G31@37mbr)

IMPORTANT NOTE: -

WARNINGS

- The glass front of the fire act as a dress guard, conforming to BS 1945 (1971) and satisfies the heating appliance regulations (1991) However, a guard conforming to BS6539 (1984) must be used to protect young children, the elderly or infirm.
- **This appliance incorporates a safety device in the form of an Oxygen depletion system. IT MUST NOT BE ADJUSTED OR PUT OUT OF OPERATION! THIS IS A NON-SERVICABLE ITEM AND MUST BE EXCHANGED AS A COMPLETE ASSEMBLY; USING ONLY THE ORIGINAL MANUFACTURER'S PART.**
- A non-combustible hearth must be provided to comply with the building regulations, or a suitable proprietary fire surround with a 150°C minimum rating.
- During initial firing, an odour may be evident. This is the starch binder used during the manufacture of the fibre components of the fire, and there are **no harmful** effects produced.
- Care must be taken to prevent any damage being caused to surrounding soft furnishing or decoration; e.g. many embossed vinyl wall coverings may become discoloured if placed too close to the appliance.

Note: Dampers or register plates must not restrict any of the above flues. The flue must only service a single appliance and not have any branches or traps, which may impede the natural draught. If a terminal is fitted it must be suitable for the purpose.

Note: A non combustible hearth must be provided beneath the appliance and must extend outwards all around the appliance base. The hearth must be level and have a minimum thickness of 12mm and must have a clearly defined edge (change of level) to discourage placing of any combustible materials on or partially over it.

SECTION EIGHT Siting the Appliance (Installation Instructions)

- **REAR EXIT: - Using Closure Plate Provided.**

The Stove can be fitted by using the Closure Plate provided & Elbow Spigot attached directly to a chimney opening.

The Stand off Brackets MUST be attached prior to fitting (see page 19). The Chimney must have an effective height of at least 3 metres. The Elbow spigot can be unscrewed and rotated 180 degrees and fastened so that it protrudes horizontally out of the back of the Stove and through the Closure Plate. The Elbow Spigot must be sealed to the Draught Diverter with a suitable high temp silicone. A distance of 45mm Min must be maintained between the rear of the Stove and Closure Plate as this will allow air flow to the Draught Diverter at the rear. The flue spigot must be capable of passing through the closure plate with a minimum clearance of 50mm between its open end and the nearest obstruction. The Flue Pipe must be 125mm (5ins) minimum diameter can be lengthened by a maximum of 150mm (6ins) between the Elbow and Closure Plate.



- **REAR EXIT: - Using Elbow Spigot and a 90 degree Bend.**

The Stove can be fitted by using the Elbow Spigot provided attached horizontally on the Stove and connected to a 90 degree elbow so that the flue goes up vertically to a Closure Plate attached to the bottom of a chimney or a flue liner of 125mm (5ins) minimum diameter and 3 metres minimum effective height, conforming to BS 715. The Flue can be lengthened between the Elbow Spigot and 90 degree Elbow by a maximum of 150mm (6ins).



- **TOP EXIT: - Using Register Plate (not provided).**

The Stove can be fitted by using the Elbow Spigot provided attached vertically to the Stove and sealed using a suitable high temp silicone and going up directly to a Register Plate (not provided) attached to the bottom of a chimney with a minimum effective height of 3 metres. The Flue Pipe can be lengthened from the Elbow Spigot to the Register Plate.

In addition it is strongly recommended that any furniture or other combustible materials are kept at least 900mm clear from the front of the stove.

Due to the fact that combustible shelves, timber fireplaces and beams have potentially thousands of possible configurations in conjunction with stoves outset or inserted partially or fully into chambers, it is not possible to give firm guidance on dimensions to these features. As a guideline, materials that are in 'line of sight' to the stove are more likely to overheat due to direct radiation from the stove body than materials that are not in 'line of sight' (e.g. with stove fully inside a chamber). Materials above the stove are more likely to overheat than materials alongside or below. A guideline limiting temperature for solid timber (not surface finishes) is approximately 80-85 degrees C with a normal ambient room temperature. Temperatures of combustible materials can be substantially lowered with a simple heat shield constructed of a non-combustible material and small air gap between the shield and combustible material.

Clearance to Shelf

Minimum clearance from hearth to underside of combustible shelf should be 740mm provided the shelf depth is 75mm (3"). This gives a minimum clearance above the appliance of 150mm. For a shelf of 150mm (6") the minimum height above the hearth must be 800mm. This will give a minimum clearance above the appliance of 220mm. For other depth refer to the shelf chart.

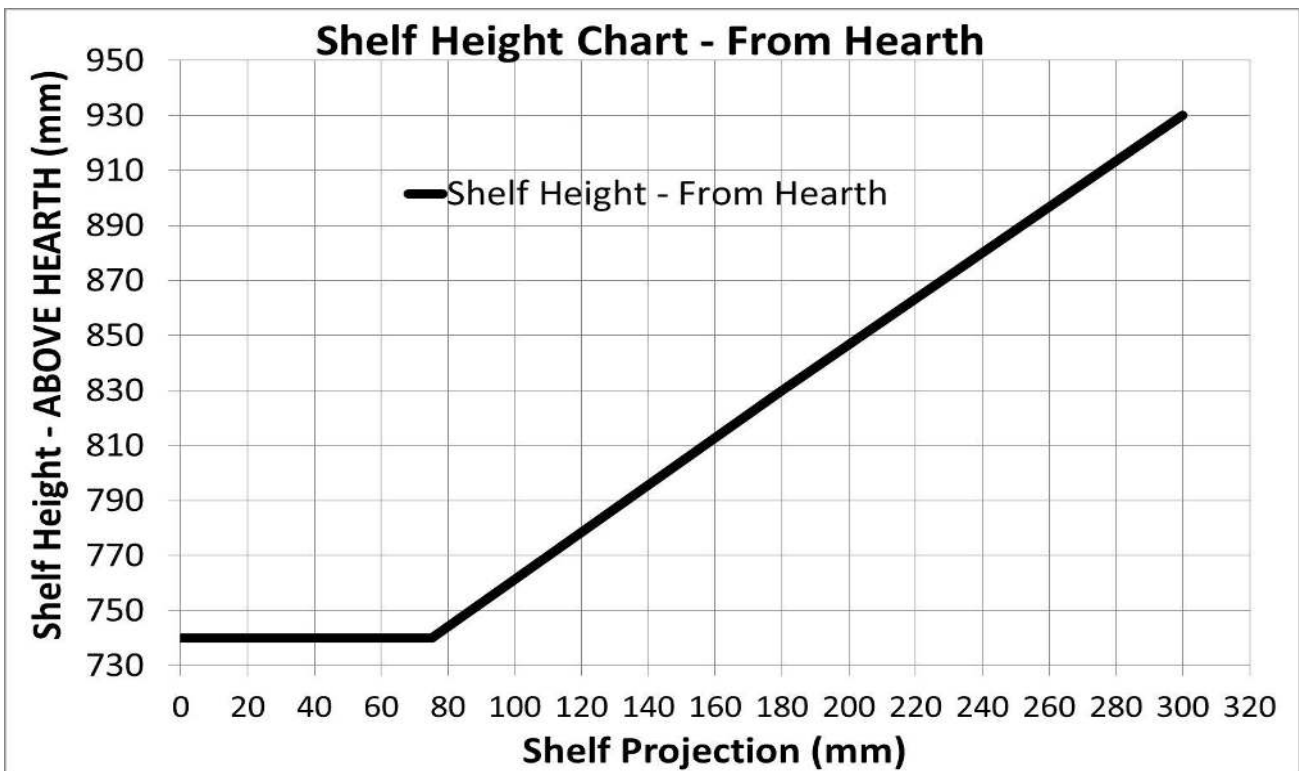

Clearance to Sides of Fire

Minimum width between vertical sides of combustible surround and the sides of the stove should not be less than 300mm provided fire is central to the surround and sides do not project more than 50mm. When vertical side forward projection is increased by 12.5 mm add 50 mm to inside width of surround.

Distances from NON-combustible materials:

- The stove can be recessed in a suitable sized non-combustible fireplace but a permanent free air gap of at least 50mm must be left around the sides and top and at least 45mm at the back of the stove to obtain reasonable heat output and for access to the stove for removal and maintenance. A clearance of 150mm will give a better heat output
- When installing the FIRELINE FXW/FPW Gas Stove, careful consideration should be made to the siting of the appliance as a spillage test will need to be carried out at the Draught Diverter at the rear of the stove.
- When siting into an Inglenook, consideration should be made for access to the rear of the appliance, either from top or sides of the stove so a spillage test can be witnessed. A small mirror may be required.
- A minimum of 45mm needs to be left between the rear of the stove and the closure plate or back wall for correct operation of the stove, this will be attained when the two Stand off Brackets are attached at the bottom rear of Stove.



Important: - The Standoff brackets must be attached to the bottom rear of the Stove prior to installing, Please see above picture.

SECTION NINE To Install the Appliance (Installation Instructions)

CHECKING THE FLUE AND FIRE OPENING

- Check that the chimney conforms to the required specifications as previously stated. Examine the condition and carry out any remedial work including removing any debris from the base.
- If the flue has been used for solid fuel it should be swept prior to the installation
- Prior to installing the appliance a smoke test (using a smoke bomb) should be carried out to check that satisfactory smoke clearance has been established.

If all the smoke is not drawn into the flue, pre-heat the flue with a blowtorch or similar and re-check. If there is any uncertainty examine for the cause and, if necessary, seek expert advice.

No combustible material should be fitted inside the fireplace opening.

GAS SUPPLY ROUTING :-

Use rigid or semi – rigid tube to connect the supply. Determine the gas supply pipe route to the appliance before installing the Stove.

CONNECTING THE GAS SUPPLY :-

The gas connection is underneath the Stove towards the front on the right hand side, The burner tray inlet pipe drops down through the stove and the test point nipple and isolation point can be connected there. The gas supply pipe can be routed either from the sides or rear.

STOVE SITING WITH CLOSURE PLATE:-**Method 1**

- A non combustible hearth must be provided beneath the appliance and must extend outwards all around the appliance base.
- The stove should be positioned onto a solid non combustible hearth with a minimum thickness of 12mm and must have a clearly defined edge (change of level) to discourage placing of any combustible materials on or partially over it.
- The stove can be levelled if necessary by using the screws in the legs with a 14mm spanner at each corner.
- The Closure plate must be securely fastened to the fire place opening and sealed using a suitable heat resistant material so no products of combustion can leak out back into the room. The front of the fireplace should be flat over an area sufficient to ensure a good seal with the closure plate. The flat surface should extend for a height equal to that of the closure plate plus 20mm and for a width equal to that of the closure plate plus 40mm.
- The closure plate measures 600mm high by 460mm wide & must be fitted and sealed to the fireplace opening using a suitable heat resistant material.

CHECKING GAS SOUNDNESS

- Turn on the gas supply to the appliance and check for soundness in accordance with current codes of practice.
- Turn off the gas supply at the external Isolation valve.
- Remove the pressure test point screw from the inlet elbow and connect the pressure gauge.
- Turn on the gas to the appliance at the Isolation valve.
- Rotating the control to the ignition position and push in to allow the air in the pipe to be purged.
- Rotating the control knob a few times, check that the electrode is sparking at the gap between the thermocouple tip and the electrode; continue until pilot ignition is established.
- Depress the control knob slightly and rotate anticlockwise until the raised pointer is aligned with the large flame symbol on the control panel.
- Check the inlet pressure is 20mbar Natural gas (G20) or 37mbar Propane (G31).
- Turn off gas supply, at the isolation valve. Disconnect the pressure gauge and replace the pressure test point screw.
- Turn on the supply to the appliance and check the pressure test point for soundness with detection fluid.

[SECTION TEN Checking Operation of Fire \(Installation Instructions\)](#)**LAY FUEL BED****Important: -**

Refer to the 'Heath & Safety Notice located on page 5 of this booklet before laying or replacing any refractory material.

In the event of replacing fuel bed components please use only the specified number of components as illustrated. Only use fuel bed component provided for this appliance. In the interest of safety and efficiency of your appliance when replacing the fuel bed it is essential that the existing fuel bed be removed and the new components are replaced correctly as a complete set.

Lay Log fuel bed as described under Users Section.

Warning:

It is important that the fuel bed components are positioned as shown in these instructions.

If the fuel bed components are not positioned correctly this may result in damage to the glass.

DOOR CLOSURE AND SECURING OF THE DOOR:-

- Close the door at the handle making sure that the seal is correctly positioned to make a good tight seal and refit the Allen screw to the side of stove. This is for safety reasons so the Door cannot accidentally opened by knocks to the handle.

CHECKING FOR COMBUSTION PRODUCTS CLEARANCE

IMPORTANT:-The smoke test must be carried out with the fire starting from cold.

- Light the fire and leave at maximum input.
- Close all the doors and windows.
- After five minutes fit the smoke match in a holder and position as illustrated with the head of the match just inside the test opening.
- Run the match along the bottom edge of the Draught Diverter **All smoke** must be drawn into the test opening if the clearance is satisfactory.
- If spillage occurs wait a further five minutes and repeat the test.
- Repeat the test with doors open and with any extractor fans in other rooms in operation.
- If spillage is detected the cause must be discovered and the fault

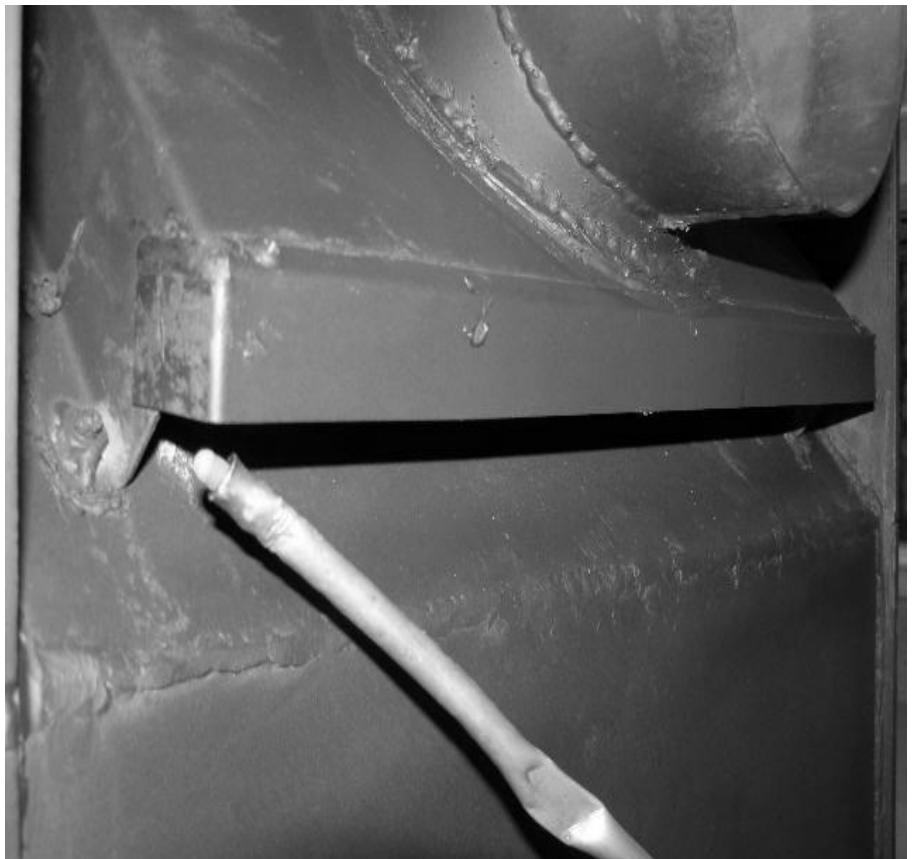

corrected, if the fault cannot be corrected, disconnect the fire from the gas supply and seek expert advice. Spillage can be caused by a restriction in the flue system, down draught or insufficient ventilation into the room where the fire is installed.

ADVISE CUSTOMER THAT:

- The glass front of this fire acts as a dress guard, conforming to BS 1945 (1997) and satisfies the heating appliance regulations (1991) however; a fireguard conforming to BS6539 (1997) must be used to protect young children, the elderly, or infirm.
- The curing effect of heating the logs and other refractory components will cause an initial odour. This is due to the starch used in the manufacturing process and is non-toxic.
- Any debris should be cleaned from the appliance. A vacuum cleaner can be used but only after all the loose log shapes and vermiculite has been removed.
- The appliance should be serviced annually by a competent person in accordance with these instructions and the appliance checked for spillage in accordance with the method detailed in these instructions.
- Demonstrate the lighting and extinguishing procedures to the user. Refer to the user section of this booklet.
- If ventilation is fitted for any reason it must be checked regularly to ensure freedom from obstructions.

Hand these instructions over to the user.**SECTION ELEVEN Maintenance (Maintenance Instructions)****GENERAL**

- Servicing should be carried out annually by a competent person such as a Gas Safe-registered person in accordance with the relevant regulations, to ensure the safe and correct operation of the appliance.
- Before commencing any service or replacement of parts, turn off the gas supply to the fire. After servicing check for gas soundness.
- When ordering spare parts please quote appliance name and serial number, these can be found on the data badge, which is located on the left hand side of the appliance behind the trim or fascia.
- At least once a years check for debris in the catchment area behind the fire and in the flue way.
- If soot has accumulated checks to establish cause rectify and clean flue or chimney accordingly.

PILOT LINTING

Check pilot aeration holes for linting; use a vacuum cleaner nozzle taking care not to damage the pilot head. The aeration hole in the pilot body may be partially blocked with dust, pet hairs, or other foreign matter. The source of this debris could be such things as carpet fibres, decorating dust or pet hairs etc. To gain access to the pilot remove the Gas Control Knob by loosening the two retaining screws, remove the Allen Screw on the Door handle catch on left hand side, and open the door. The Log Fuel Bed will need to be removed for access around the pilot.

The pilot is located on the left hand side of the appliance, any debris in or around the aeration hole can usually be removed using the nozzle of a vacuum cleaner around the top of the pilot assembly, this usually draws it out of the aeration hole. It is advisable not to blow the debris into the hole or pilot assembly as this may cause more of a restriction and not rectify the problem.

TO REMOVE THE BURNER TRAY

- Turn off the gas supply by the isolating elbow.
- Remove the Gas Control Knob by undoing the two screws on the rear, then undo the Door Handle fixing Allen screw on left hand side and open door.
- Remove the fuel bed components and vermiculite.
- Undo the two tray retaining screws and remove the tray, I
- Lift the tray up and twist sideways and remove.

REPLACEMENT OF GAS CONTROL

- Follow the burner tray removal sequence.
- Disconnect the thermocouple from the end of the valve.
- Disconnect the inlet pipe and injector pipe.
- Undo the locknut holding the valve on to the support bracket.
- Remove the valve.
- Replace in the reverse order taking care not to over tighten the thermocouple in the end of the control valve.

REPLACEMENT OF INJECTOR

- Follow the burner tray removal sequence.
- Undo the compression nut on the supply pipe.
- Unscrew the locking nut holding the injector on the chassis.
- Clean or replace the injector.

NOTE: -Do not use a wire or a drill to clean out holes. Injectors are different sizes. Refer to the appliance data section for details.

- Re-assemble in reverse order.

REPLACEMENT OF OXY-PILOT ASSEMBLY

NOTE: If the pilot assembly is replaced it must be replaced by an identical unit from the same manufacturer and replaced as a complete unit.

- Isolate restrictor elbow under stove and disconnect supply pipe from stove.
- Remove the Gas Control Knob by undoing the two screws on the rear, then undo the Door Handle fixing Allen screw and open door.
- Undo the two tray retaining screws on the tray (do not completely remove) and lift out from the back.
- Undo the compression nut on the supply pipe at the pilot.
- Carefully pull off the ignition lead.
- Disconnect the thermocouple at the end of the main control valve.
- Remove the cross headed screws holding the pilot to the tray chassis
- Carefully remove the oxy-pilot.
- Re-assemble in reverse order.

FLUE CHECK

- It may be necessary to remove the stove to gain access to the flue system: - Reversing fitting instructions, but first remove Log Shapes, Bark and Vermiculite.
- Examine flue and rectify as necessary.
- Replace the stove, referring to fitting instructions.

SECTION TWELVE Short Spare's List

Parts may vary/change due to development of products. A serial number should always be supplied when ordering parts to make sure you receive the correct part.

Parts able to be ordered by customer	
Part Description	Part Number
Log set	6394
Pilot Shield	7195
Cool touch handle	7028
Parts that require a GAS SAFE engineer to order/fit	
Part Description	Part Number
Valve	5932
Silencer (NG)	5271
Silencer (LPG)	6393
Oxy Pilot (NG)	6952
Oxy pilot (LPG)	3566

Register your appliance online today to active your warranty



GAS FIRE COMMISSIONING CHECKLIST

This Commissioning Checklist is to be completed in full by the competent person who commissioned the gas fire as a means of demonstrating compliance with the appropriate Building Regulations and then handed to the customer to keep for future reference.

Failure to install and commission according to the manufacturer's instructions and complete this Benchmark Commissioning Checklist will invalidate the warranty. This does not affect the customer's statutory rights.

Site Requirements	Yes	N/A
Was the chimney checked to ensure it only serves one flue/fire, has no obstructions and is continuous?		
Has any debris at the base of the chimney been removed?		
For brick chimney installations is there enough depth for 12 litres of debris, or precast flues 2 litres of debris? (see instructions for debris gap details)		
Have damper and register plates been removed or locked in the fully open position ensuring correct size of flue is maintained?		
If previously used for solid fuel has the chimney been thoroughly swept?		
If the chimney is pre-cast has the inside of the flue been checked for extruded cement / sealant which must be removed?		
Has the fire place been checked for under-floor air supply which must be sealed off?		
Has the chimney been inspected prior to fitting the gas fire to ensure that it is in good condition?		
Has the structure of the chimney been checked for leakage using a smoke pellet test? (See BS5440-1 for details).		
Ventilation		
Does the installation require any additional ventilation requirements as detailed in the manufacturer's instructions?		
Hearth Requirements- where fitted		
Is the hearth constructed from non -combustible material?		
Is the hearth a minimum of 12mm thick with a minimum floor to top surface of 50mm?(BS5871) or as per manufacturer's instructions?		
Is the hearth for open fronted fires a minimum of 760mm wide and has 300mm projecting from the fire opening (BS6871) or to manufacturer's instructions?		
Mounting height (where applicable) has the fire been installed to the correct mounting height- as per manufacturer's instructions?		
Firebox and Fuel Bed		
Has the fuel bed, coals, pebbles etc. been fitted to manufacturer's instructions?		
Gas Supply		
Has an isolation tap/restrictor inlet elbow been fitted for servicing?		
Has the gas supply been thoroughly purged prior to connection to remove any debris?		
Has a gas tightness test been completed prior to breaking into the gas supply and following completion of installation?(IGEM/UP/1B)		
Record burner gas pressure reading? If only the supply pressure is available a gas rate must be undertaken.(GSIUR REG26/9C)		
Record dynamic inlet gas pressure (working pressure) reading (all gas appliances running)		
Spillage test		
Installation passes smoke match test with any extractor fans turned on (see manufacturer's instructions)		
Installation		
Has the gas fire been installed and commissioned in accordance with manufacturer's instructions?		
Has the fire been installed with the correct clearance to combustible materials, as per manufacturer's instructions?		
The operation of the appliance and controls have been demonstrated to the customer including battery replacement where applicable?		
The manufacturer's literature, including Benchmark Checklist and Service record has been explained and left with the customer?		
Has the appliance been registered with the Local Authority as detailed on the Gas Safe web site and is a legal requirement and forms part of the warranty?		
Customer's Signature: (To confirm satisfactory demonstration and receipt of manufacturer's literature)	Commissioning Engineer's Signature:	

*All installations in England and Wales must be notified to be Local Authority Building Control (LABC) either directly or through a Competent Persons Scheme. A Building Regulations Compliance Certificate will then be issued to the customer.

SERVICE RECORD

It is essential that your gas fire is serviced regularly and that the appropriate Service Interval Record is completed. Service Provider

Before completing the appropriate Service Record below, please ensure you have carried out the service as described in the manufacturer's instructions. Always use the manufacturer's specified spare part when replacing controls.

SERVICE 01	Date:
Engineer name:	
Company name:	
Telephone No:	
Gas safe register No:	
Comments:	
Signature	

SERVICE 02	Date:
Engineer name:	
Company name:	
Telephone No:	
Gas safe register No:	
Comments:	
Signature	

SERVICE 03	Date:
Engineer name:	
Company name:	
Telephone No:	
Gas safe register No:	
Comments:	
Signature	

SERVICE 04	Date:
Engineer name:	
Company name:	
Telephone No:	
Gas safe register No:	
Comments:	
Signature	

SERVICE 05	Date:
Engineer name:	
Company name:	
Telephone No:	
Gas safe register No:	
Comments:	
Signature	

Fireline FXW/FPW GAS STOVE (NG) & (L.P.G.) LOG

Product ID Label	A-0399	Serial No Prefix	NL/NM N.G.
	A-0401		
	A-0403		NP/NQ L.P.G.
	A-0404		
Burner Tray / Box Assembly			
Restrictor Elbow (2189)			
Log Fuel Bed (6394)			
Bag of Vermiculite			
Bag of Bark Chips			
Glass Panel			
Closure Plate			
Fixing Kit (3xAllen keys/stand off brkt/bolts)			
Data Badge			
Warning Label			
ID Label & Packing Labels			
Owners Book			
Bottle Of Black Paint			
Handle			
Semi Circle Restrictor Plate			
Spigot Gasket			
Flue Spigot			
Button Magnets x 4 (Part No 4159)			
Serial Number			
Inspector			