

Charlton & Jenrick^{LTD}

Best of British fires, fireplaces & stoves

LED Electric Fire

Model: 4D Ecoflame 1250E/1500E/1800E

INSTALLATION AND OPERATING INSTRUCTIONS

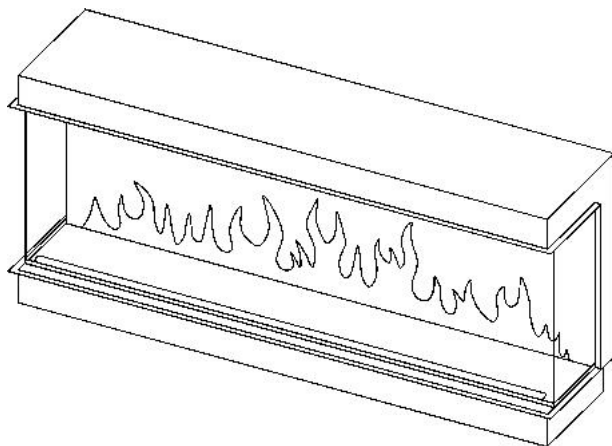

**Please read the instructions carefully before installation
or use and keep for future reference.**

CONTENTS

1. Important Safety Information	1
2. Technical Specifications	2
3. Parts and Hardware	3
4. Appliance Dimensions	5
5. Installation Instructions	5
6. Operating Instructions	10
6a. Manual Control Panel	11
6b. Remote Control	12
7. Maintenance	18
8. Service Parts list.....	19
9. Others	21

1. IMPORTANT SAFETY INFORMATION

- 1.1 **Read all the instructions carefully before using the appliance .**
- 1.2 For **indoor use only**. This appliance is not suitable for use outside
The house
- 1.3 Do not use this appliance in the immediate surroundings of a bath,
a shower or a swimming pool.
- 1.4 Do not use this fire as a free-standing appliance. It must always be
secured to the wall, fireplace mantel, or floor etc.
- 1.5 This fire must not be located immediately below a socket-outlet.
- 1.6 This appliance must be earthed.
- 1.7 This appliance must not be supplied through an external switching
device, such as a timer, or connected to the circuit that is regularly
switched on and off by utility to avoid a hazard due to the
inadvertent resetting of the thermal cut out.
- 1.8 If the power cord is damaged, it must be repaired,
By an approved competent person
- 1.9 **Do Not Cover *warning label***: to avoid overheating, do not
allow the appliance to be covered or let the air inlet/outlet become
obstructed. Please note the warning on the appliance.
- 1.10 To reduce the risk of fire, keep textiles, curtains, or any other
flammable material a minimum distance of 1 meter from the heater
outlet.
- 1.11 Keep the power cords away from hot surfaces and hot conditions.
Do not route the power lead in front of the appliance.
- 1.12 Do not use this fire in rooms that have explosive gas in them (for
example petrol), or if you are using solvents, glue, aerosol spray
or in flammable paints, as these may catch fire.
- 1.13 This appliance can be used by children aged from 8 years and
above and persons with reduced physical, sensory, or mental
capabilities or lack of experience and knowledge if they have been
given supervision or instruction concerning use of the appliance in
a safe way and understand the hazards involved. Children shall

not play with the appliance. Cleaning and user maintenance shall not be made by children without supervision.

1.14 Children and vulnerable people must be always supervised when using this appliance, as some parts can become very hot and cause burns. A suitable fireguard must be fitted for this purpose.

1.15 Do not use this appliance in small rooms when they are occupied by persons not capable of leaving the room on their own, unless constant supervision is provided.

1.16 Cleaning and user maintenance shall not be made by children without supervision.

1.17 Keep the power plug accessible after installation for the purpose of isolation

1.18 Children of less than 3 years should be kept away unless continuously supervised or a fireguard is fitted

2. TECHNICAL SPECIFICATIONS

Model No.: 4D Ecoflame 1250E/1500E/1800E

Supply Voltage: AC 230-240V 50Hz

Maximum power consumption: 1500W

Power for flame and fuel bed effect:

Model	1250E	1500E	1800E
Power	40.1W	48.1W	50.1W

Power for mood light: DC12V 9W 0.75A

Heat Output:

Nominal heat output (P_{nom}): 1500W

Minimum heat output (indicative) (P_{min}): 750W

Maximum continuous heat output (P_{max}): 1500W

Auxiliary Electricity Consumption :

At nominal heat output (e_{max}): 12.5W

At minimum heat output (elmin): 12W

In standby mode (elSB): 0.49W

Type of Heat Output / Room Temperature Control



Single stage heat output and no room temperature control	No
Two or more manual stages , no room temperature control	No
With mechanic thermostat room temperature control	No
With electronic room temperature control	Yes
Electronic room temperature control plus day timer	Yes
Electronic room temperature control plus week timer	Yes





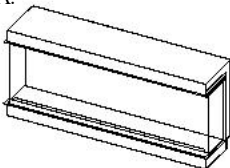

Other Control Options

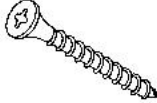

Room temperature control, with presence detection	No
Room temperature control, with open window detection	Yes
With distance control option	No
With adaptive start control	Yes
With working time limitation	No
With black bulb sensor	No

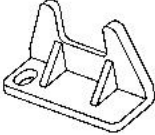
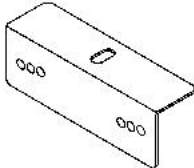
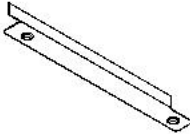
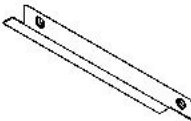
3. PARTS AND HARDWARE

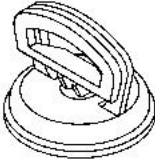
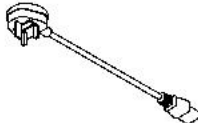
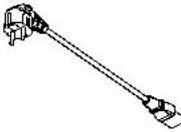
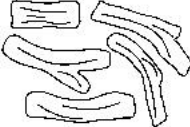
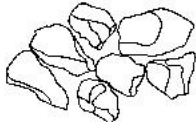
- 3.1 Unpack the fire carefully and make sure that the appliance is intact with no signs of damage caused by transport and no part has been exposed to water. If in doubt, do not use the appliance and contact an authorised your retailer.
- 3.2 Keep plastic wrapping away from children.
- 3.3 Save the original packaging as this may be required in the event of service complaint with product.
- 3.4 Check that all parts are removed from the packing.

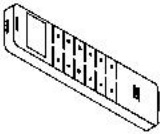
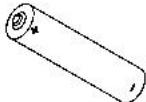
<p>A.</p>  <p>Firebox (1pc)</p>	<p>B.</p>  <p>ST4*8 Screw (5pcs)</p>	<p>C.</p>  <p>ST5*40 Screw (18pcs)</p>
--	---	---

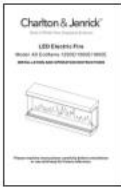
<p>D.</p>  <p>ST4*40 Screw (4pcs)</p>	<p>E.</p>  <p>Wall Plug (18pcs)</p>	<p>F.</p>  <p>Power Cord Bracket (1pc) Installer must fit before leaving appliance</p>
<p>G.</p>  <p>Lower Brackets (2pcs) To be used when the Wall Hanging Bracket (J) is used</p>	<p>H.</p>  <p>Edging Strips (2pcs)</p>	<p>I.</p>  <p>Edging Strips (2pcs)</p>
<p>J.</p>  <p>Wall hanging bracket is attached on firebox (1pc) Remove from the appliance if you are not fixing to wall</p>	<p>K.</p>  <p>1250E (1pc) 1500E/1800E (2pcs)</p>	<p>L.</p>  <p>Power Cord (1pc)</p>
<p>M.</p>  <p>Power Cord EU (1pc)</p>	<p>N.</p>  <p>Plaster Logs (1set)</p>	<p>O.</p>  <p>Black Glass (1set)</p>
<p>P.</p>  <p>Vermiculate (1set)</p>	<p>Q.</p>  <p>Remote (1pc)</p>	<p>R.</p>  <p>AAA Battery (2pcs)</p>

<p>S.</p>  <p>Instruction Manual (1pc)</p>	<p>T.</p>  <p>Simplified Instruction (1pc)</p>	
---	---	--

4. APPLIANCE DIMENSIONS

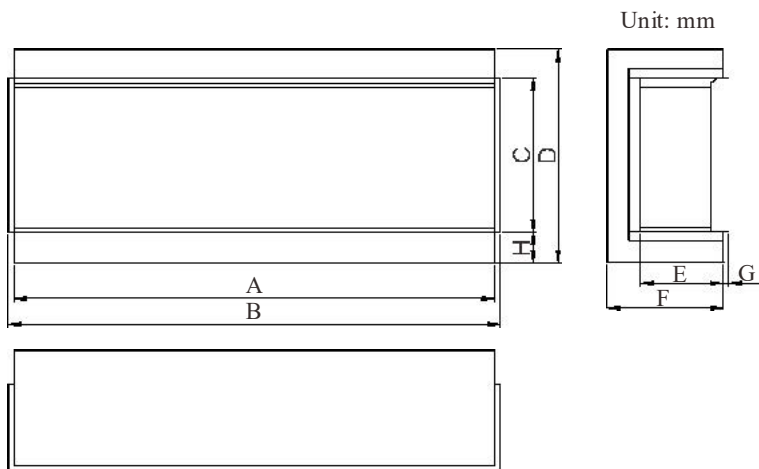

Model	A	B	C	D	E	F	G	H
1250E	1250	1280	402	560	214	300	15	79
1500E	1500	1530	402	560	214	300	15	79
1800E	1800	1830	402	560	214	300	15	79

5. INSTALLATION INSTRUCTIONS

5.1 PREPARATION BEFORE INSTALLATION

Tools Required

A screwdriver, a spirit level and drill will be needed.

Prepare the Appliance

Your new electric fireplace may be installed virtually anywhere in your home. However, when choosing a location, ensure that the general instructions are followed:

For best result, install out of direct sunlight, water, or very damp air.

The appliance must be connected to an earthed electrical outlet and it must be easily accessible to allow disconnection.

Connect the power cord into rear of appliance

It is very important that the plug is tightly located into the socket in rear of appliance. It is essential that the retention clip provided is fixed in place using the ST4*8 screw ensuring a secure connection to the appliance. It is recommended that you turn on and operate the appliance to check that all functions and that there are no issues with the appliance

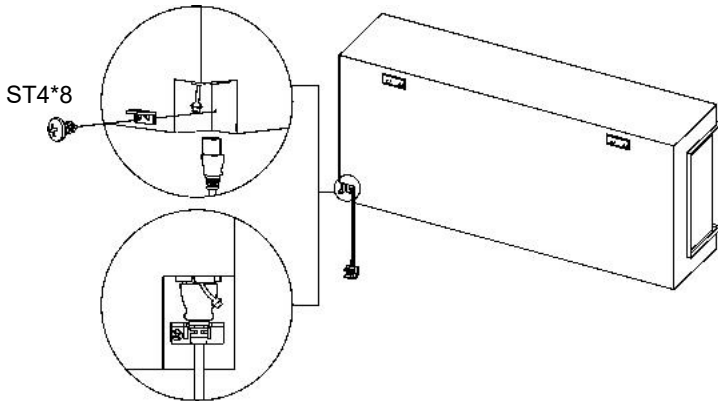

Connect the mood light cable

The interface of the mood light cable is on the rear of the appliance, near the position of the power cord. Please also check the function after connecting the mood light.

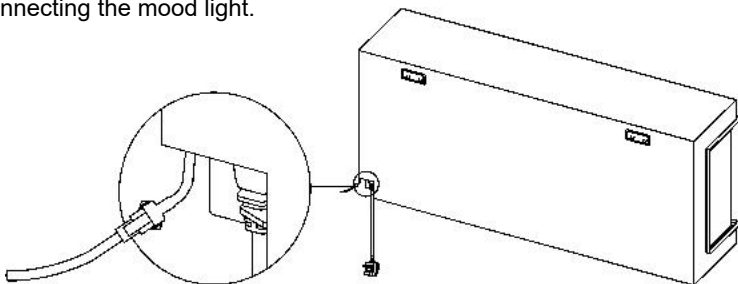

Note: Compatible mood lighting devices are available from Charlton & Jenrick Ltd., Other brands may not be suitable and void the warranty.

Preparing the casing

The appliance can be installed in 3 different arrangements. They are as follows:

Front view (only the front window is visible)

When you unpack the appliance, you will notice that the side panels have been fixed on the appliance, which makes the appliance visible on only one front side.

Front and one side view (the front and one of the side windows are visible)

Front and two sides view (the front and both sides windows are visible)

Remove the side panels from the ends you want to view to enable dual or triple aspect as required. Then fix the edging strips using the screws taken from the removal of the side panel(s).

Removing the front glass panel

Remove the 2 c/s screws and remove the glass retaining strip as shown below

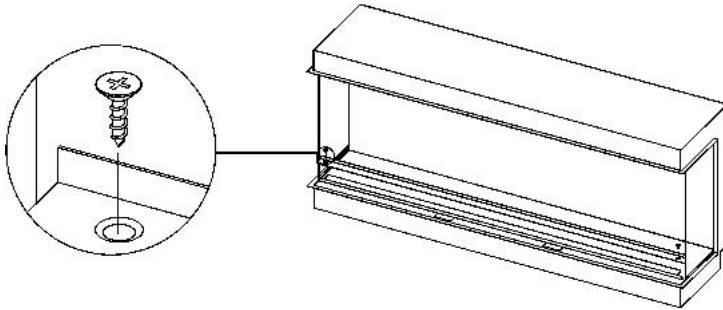

Use a suction cup(s) provided to support the middle of the glass panel, lift the panel upwards and pull it forwards at its lower edge carefully lift glass away as shown below.

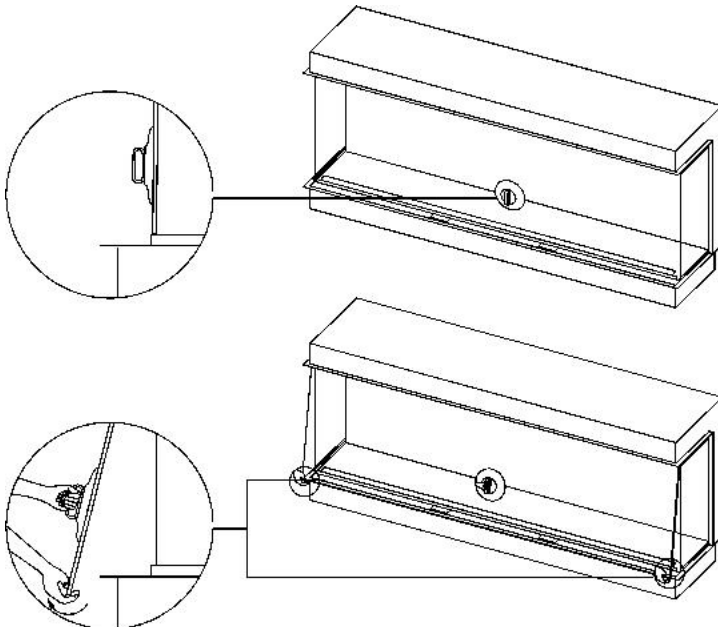

5.2 Install ing the Appliance

The following is only given as a general guide because it can be installed in so many ways, provided you ensure electric connections are safely made in accordance with the codes, various materials can be used for the framework and cladding. But consideration should be made to soften the internal surfaces of any cladding to minimise that amplification of noise.

Flush Mounted Installation

Prepare the framework as a general guide only see picture below:

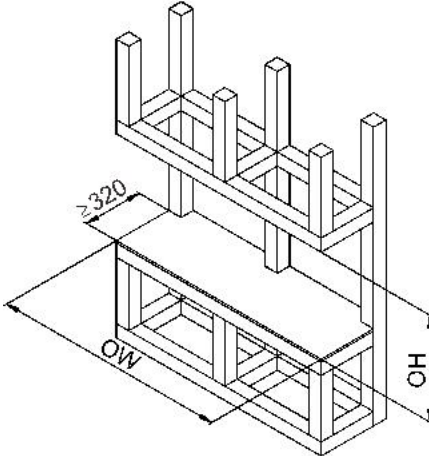

Unit: mm

Model	OW	OH
1250E	1260	575
1500E	1510	575
1800E	1810	575

NOTE: Ensure a firm flat positioning of the appliance and secure fixing to avoid vibration and movement of the appliance after cladding .

Position the appliance into the framework and bend out the four brackets on the upper and lower edges of the appliance, so they can fix with the screws provided to the framework

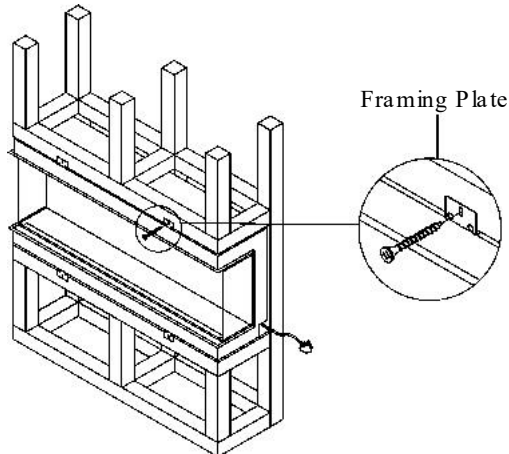

Cladding the framework note: hard surfaces can amplify sound consider adding some underlay or similar to the inside surface of the cladding

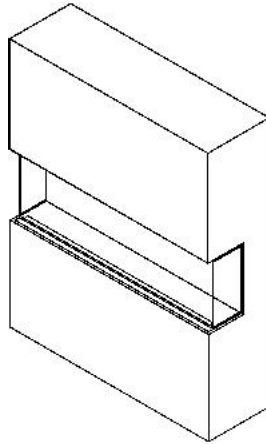

Wall Mounted Installation

Remove the wall bracket from the rear of the appliance, and place it horizontally against the wall. Using the wall as a template mark the hole position as shown in the figure below.

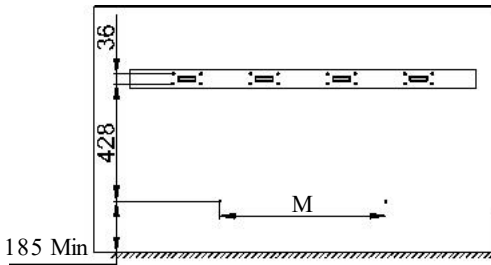

Unit: mm

Model	M
1250E	648
1500E	1000
1800E	1200

Mark the positions for the lower brackets

Drill holes and using wall plugs prepare for the fixing of lower brackets

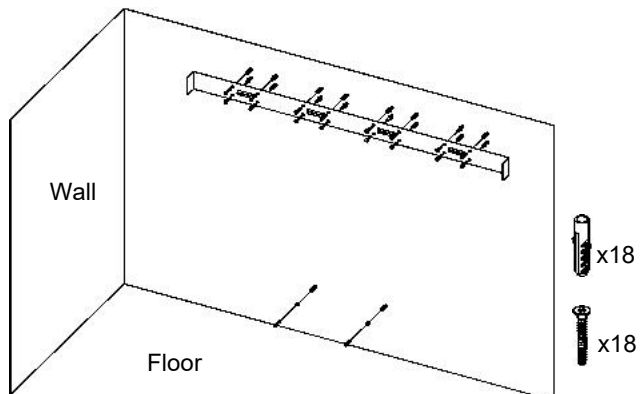

Mount the appliance carefully on the hooks of the wall bracket, secure the appliance To the wall bracket with the screws provided, one into each end

Use four screws provided to fix the bottom brackets to the corresponding holes on the underside of appliance adjusting the brackets position to ensure the appliance is plumb with the wall. Fix brackets to holes previously prepared.

Unit: mm

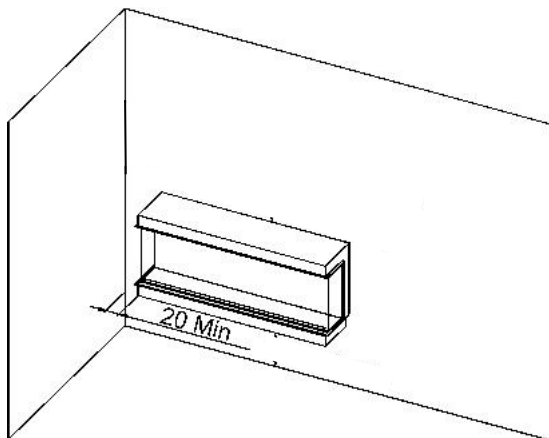

6. OPERATING INSTRUCTIONS

WARNING!

Do not operate the appliance if it is damaged or malfunctions. If you suspect the appliance is damaged or malfunctions, call a qualified service engineer to inspect the appliance, and replace any part of the electrical system if necessary, before reusing.

WARNING!

To reduce the risk of fire, keep textiles, curtains, or any other flammable material a minimum distance of 1 meter from the air outlet.

MAKE SURE the plug fits tight in the outlet. Faulty wall outlet connections or loose plugs can cause the outlet to overheat.

Do not disconnect the power at the mains supply whilst the appliance is running. Use the functions on the remote to turn the fire off and ensure the mains switch has been moved to the off position before disconnecting.

PREPARATION BEFORE USE

6.1 The appliance can be operated by both remote control and the manual controls on the appliance.

NOTE: To use both remote and manual functions, the manual on/off switch must be in 'ON' position. To prevent the product becoming too hot, there is 10s delay when turning on the heater and a 10s delay when turning off the heater fan.

Batteries

Ensure that the handset batteries are new and inserted correctly.

Main Power Switch

- 6.2 The mains power switch is located on the control panel to the side of the heater outlet.
- 6.3 Press the Main Power Switch to ON (—) before operating either the remote or manual controls buttons.
- 6.4 A long beep is heard to indicate the fire is ready for use.

6A. MANUAL CONTROL

NOTE: The manual button controls basic functions, not a full range of controls. Use the remote controls to carry out all functions.

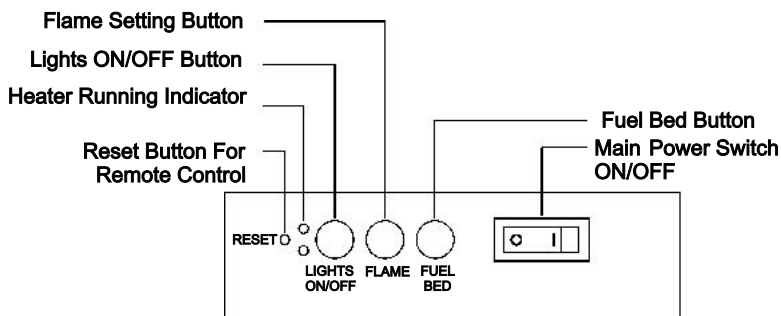

- 6a.1 **MAIN SWITCH:** Press “1” to turn on the appliance Press “0” to turn off the appliance
- 6a.2 **LIGHTS ON/OFF:** Press button LIGHTS ON/OFF to turn on/off flame, Downlight, fuel bed and mood light.
- 6a.3 **FLAME:** Press button FLAME to select 3 different flame effect and OFF setting. If the flame was turned off by pressing button LIGHTS ON/OFF and the flame was not at OFF, the current flame effect will be memorised. Otherwise, if the flame was at OFF, press button Flame to turn on the default setting.

6a.4 **FUEL BED:** Press button FUEL BED to select 14 different fuel bed colour effects and OFF setting. If the fuel bed was turned off by pressing button LIGHTS ON/OFF and the fuel bed was not at OFF, the fuel bed effect will be memorised. Otherwise, if the fuel bed was at OFF, press button Fuel bed to turn on the default setting.

6B. REMOTE CONTROLS

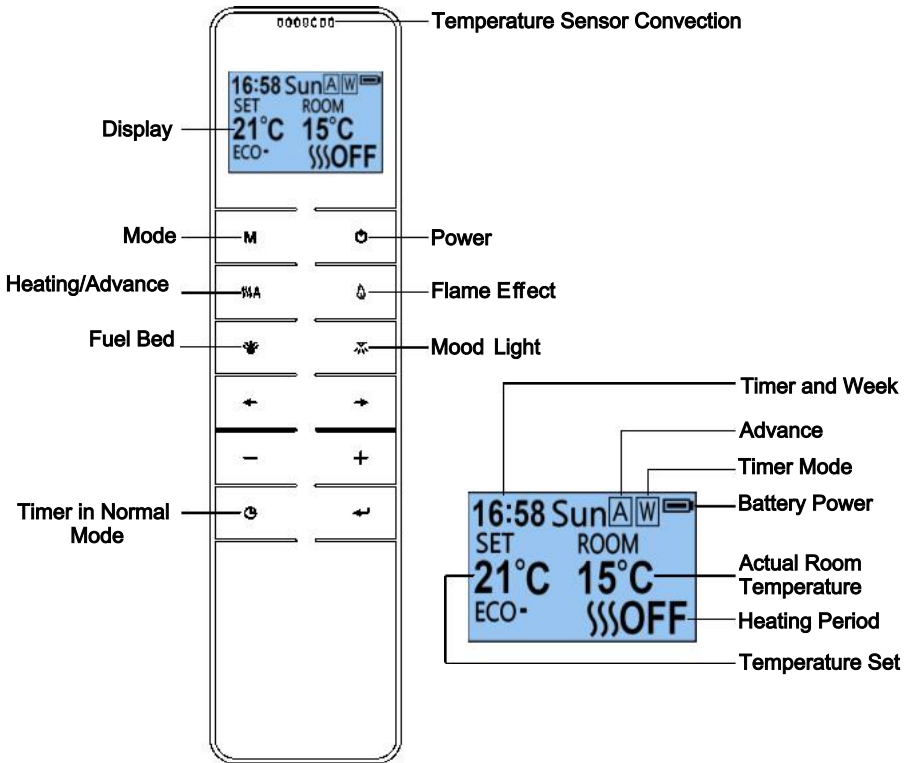

NOTE: This is a thermostatic remote control . The remote should always be in the same room as the fireplace and placed on a flat surface. It senses the room temperature so it must not be placed in a position that allows the appliance hot air to blow on it and affect the thermostatic reading.

The communication frequency between the appliance and remote has already been set up. If you have difficulty with the remote communicating with the appliance, please follow instructions Step 6b.36.

Standby for Remote Controls

6b.1 The screen shown to the right is when the remote controls is in standby mode



Turn on/off

6b.2 Press  to turn on/off the appliance.

Flame Effect

6b.3 Press  to enter the flame effect adjustment screen.

6b.4 Press the ' ← ' and ' → ' button to select 3 different of flame colours and OFF setting.

6b.5 Press the ' - ' and ' + ' button to select 5 levels of brightness and OFF setting.

After Day/Time Set Up

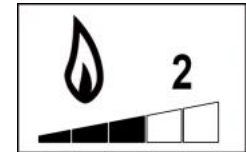

Fuel Bed

6b.6 Press  to enter the fuel bed adjustment screen.

6b.7 Press the ' ← ' and ' → ' button to select 14 Different fuel bed colours (the fourteenth is the colour cycle mode) and OFF setting.

6b.8 Press the ' - ' and ' + ' button to select the 5 levels of brightness and OFF setting.

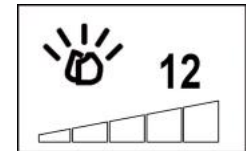

Mood Light

Note: If mood lights are not connected, please ensure the brightness is set to zero.



6b.9 Press  to enter the mood light adjustment screen.

6b.10 Press the ' ← ' and ' → ' button to select 14 different of mood light colours (the fourteenth is the colour cycle mode) and OFF setting.



6b.11 Press the ' - ' and ' + ' button to select 5 levels of brightness and OFF setting.



Normal Mode

6b.12 Normal control mode is factory set. If it is not, then press button  until the logo  shows up at the upper right corner of the screen.

6b.13 Press the ' - ' and ' + ' button to adjust the temperature from 17 °C to 25 °C by 2 intervals.

6b.14 Press  button to turn on/off heat,  ON,  OFF will show lower on the screen.

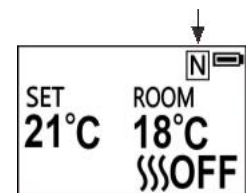

NOTE: It is normal for the fan heater to stop running for periods of time. This happens because the room temperature is at or above the temperature set on the remote control. The heater indicator will be turned off after 10s if you have the flame ON. The heater indicator will stay ON if you use the heating function only.

Count Down Timer

NOTE: This setting is only for operating in normal mode. It allows the appliance to go into standby after a set period.



6b.15 Press  to cycle through the settings from 0.5 hours to 9 hours, and then OFF. The timer logo and time will show on the screen.

The heater must be in ON position.

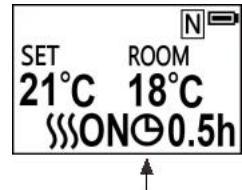
The heater can be automatically run by using daily timer and weekly timer on the remote.



Set up Day, Time, and Comfort temperature.

6b.16 Press  to turn on the remote control. Hold the button  for 3 seconds to enter the setting screen.

6b.17 Press the ' ← ' and ' → ' button to choose Day, Time and your comfortable temperature. Your selection will be highlighted.



6b.18 Pressing the ' - ' and ' + ' button will adjust the number.

Time: 24-hour system

Select your comfortable temperature from 15-25°C

Temperature unit: °C, °F

Daily Timer Heating

6b.19 The following are preset heating time periods, which can be altered if you want

06:00 until 08:30

17:00 until 22:00

6b.20 Press **M** until **D** shows at the upper right corner of the screen, then enter the daily timer heating mode.

6b.21 Hold the button **←** for 6 seconds to enter the daily timer setting. Up to 3 heating start time periods can be set.

Press ' ← ' or ' → ' to choose hour or minute,
Press ' - ' or ' + ' to set the time.

Minute will increase/decrease by 15 minutes per press.

Hold **←** for 3 seconds or wait for 10 seconds to save and exit the heating time setting.

6b.22 Adjust the set temperature

Press the ' - ' or ' + ' button to increase or decrease the temperature to suit your comfort temperature setting.

ECO means 2 °C lower than your comfortable temperature setting,

ECO- means 4 °C lower,

COMF+ means 2 °C higher,

COMF++ means 4 °C higher.

6b.23 To check your daily timer settings, press **←**

6b.24 If heating needs to be turned off, it will be necessary to go back to the Normal Mode to turn off.

Weekly Timer Heating

6b.25 The following are preset heating periods, which can be altered if you want.

From Monday to Friday

06:00 until 08:30

17:00 until 22:00

From Saturday to Sunday

06:30 until 09:30

11:00 until 13:00

17:00 until 22:00

6b.26 Press **M** until **W** shows at the upper right corner of the screen, then enter the weekly timer heating mode.

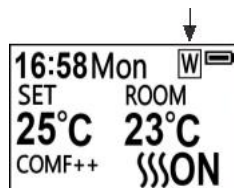
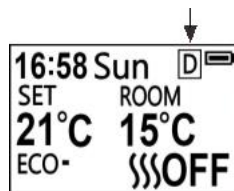

6b.27 Hold **↵** button for 6 seconds to enter the weekly timer setting.

Press '**←**' or '**→**' to move the cursor (a flashing underline), press the **↵** button in the corresponding week position to select (the character is highlighted) or cancel (the character is displayed normally) the current setting. Several days can be selected together.



Press the '**→**' button to move the cursor to the time period setting area. Press '**←**' or '**→**' to choose hour or minute, press '**-**' or '**+**' to set the number.



Up to 3 heating start time periods can be set.

Minute will increase/ decrease by 15 minutes per press.

Press the **↵** to set the heating time for the selected day and return to the week line.

Hold **↵** for 3s or wait for 10s to save and exit the heating time period setting.

6b.28 Press **↵**, '**←**' and '**→**' to check your weekly timer settings.

set period.

6b.29 If heating needs to be turned off, it will be necessary to go back to the Normal Control Mode to turn off.

Advance Mode

6b.30 Under the daily and weekly timer mode, Press: **⏏A**

6b.31 To turn the heater off when the heater is on during preset heating periods.

6b.32 To turn the heater on when the heater is off during preset heating periods.

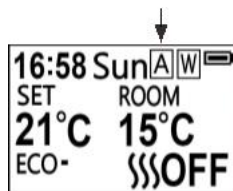

Adaptive Start Control

6b.33 Learning from the previous heating cycle enables the appliance to judge the appropriate advance time to turn on the heater to ensure that the set temperature is reached at the set time. For example, if your timer is set to start at 18:00 and temperature is set to 23°C, the fire may for example come on at 17:30 to ensure the room is 23°C at 18:00.

Window Open Detection

6b.34 When the transmitter detects a rapid drop in room temperature, it will be judged as a window open, the warning icon will be displayed and the heater will be turned off automatically.

6b.35 After the indoor temperature has risen or a manual override of the warning (by operating remote control) has been done the fire will return to normal working state.



Set up the communication between the remote and appliance

6b.36 The operations below should be carried out before programming in the case of replacing the remote control or the appliance cannot be controlled by the remote:

Hold the reset button on the appliance for 3 seconds (pen Point may needed) until you hear 3 short beeps from the unit, release the button.

Press the  button on the remote, the programming is finished when you hear a long beep from the appliance.

6b.37 Resetting the code for remote control is necessary if the appliance operates wrongly or the remote control does not operate correctly. Open the back cover of the remote control.

Press the Reset button on remote control. Refit the back cover of the remote control.

Follow the steps 6b.36



Important Safety Information for Remote Controls

6b.38 To remove the batteries, open the back cover of the remote control to remove the batteries and replace with new one. Pay attention to the positive and negative poles.

6b.39 Two 1.5V R03 alkaline batteries are required for the remote control.

6b.40 Exhausted batteries should not be left in the remote, they should be removed and safely disposed of.

6b.41 Non-rechargeable batteries must not to be recharged.

6b.42 Different types of batteries or new and used batteries should never be mixed.

- 6b.43 Ensure the batteries are inserted with the correct polarity.
- 6b.44 If the remote is to be unused for a long period, the batteries should be removed.
- 6b.45 The terminals within the remote must not to be short-circuited.

Resetting the Thermal Cut Out



- 6b.46 The appliance is fitted with an Electronic Safety Control (E.S.). This is a safety device, which switches off the fire if, for any reason, the appliance overheats, e.g., when covered. If the heater stops operating while the flame effect continues working normally, this indicates that the E.S. Control is in operation. The E.S. Control can only be re-set after the appliance has cooled down, and the appliance has been reset. Re-setting of the E.S. Control proceeds is as follows:
 - 6b.47 Switch off the appliance (Manual On/Off switch) and leave it off for approximately 10-15 minutes.
 - 6b.48 Remove any obstruction to the fan heater outlet or fan blades etc. Make sure, that the power supply is disconnected with the plug socket outlet while doing this.
 - 6b.49 Switch on the appliance and the E.S. Control should re-set.
 - 6b.50 Ensure that the appliance is functioning correctly. If the E.S. Control operates again, the appliance should be checked by a competent electrician.

7. MAINTENANCE

WARNING:

Before any maintenance or cleaning of the exterior of the fireplace, The unit should be disconnected from the power supply until it is cool off.

Remote Controls Battery Replacement

- 7.1 When the batteries are at full power, the battery symbol will show 
- 7.2 When the batteries are half full, the battery symbol will show 
- 7.3 When the batteries are out of power and need replacing immediately, the battery symbol will show 

Cleaning the Fireplace

Cleaning or polishing products are not recommended. Fingerprints or other marks on the front glass panel can be removed by a piece of soft, damp, lint-free cloth with a good quality household glass cleaner. The

front glass panel should always be completely dried with a clean, lint-free cloth or paper towel.

Caution: Abrasive cleaners should not be used on the glass panel. Liquids should not be sprayed directly onto any surface of the unit.

8. SERVICE PARTS LIST

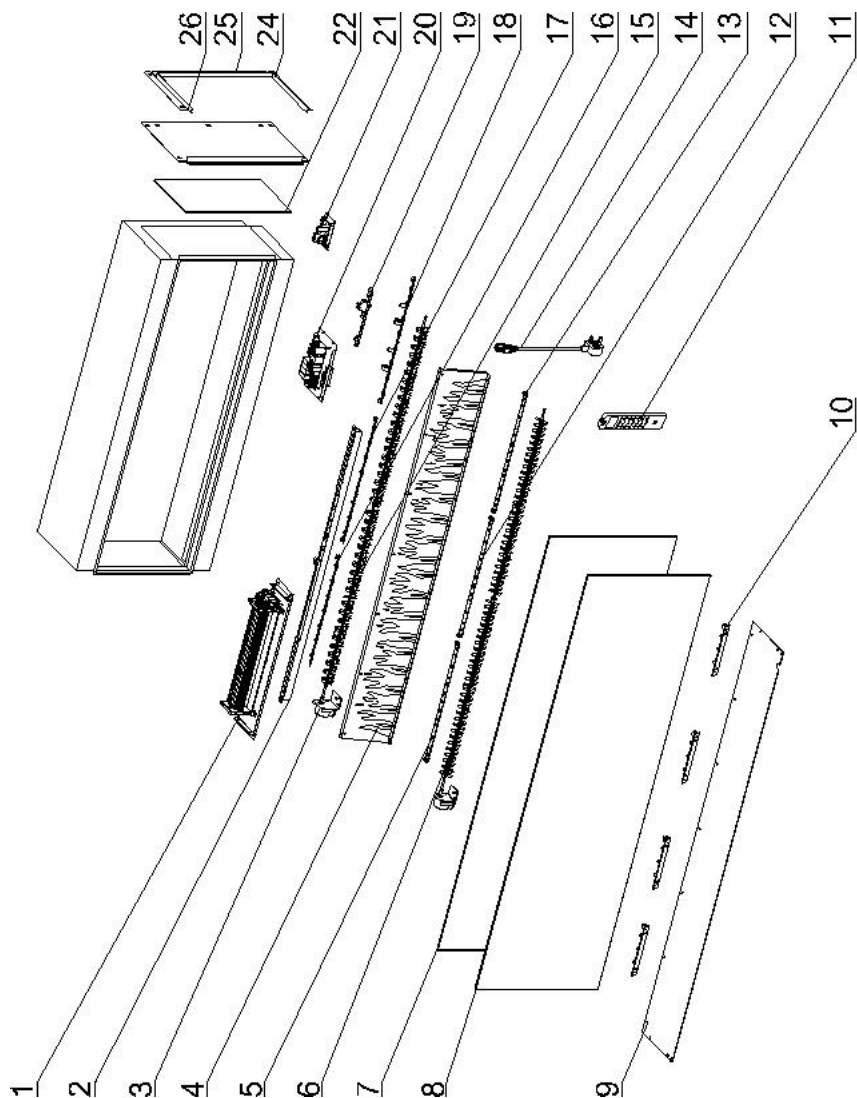

No.	Component	1250E			1500E			1800E		
		Part Number	LED Board Identifier	Qty	Part Number	LED Board Identifier	Qty	Part Number	LED Board Identifier	Qty
1	Heater Unit	8607	-	1	8607	-	1	8607	-	1
2	Down Light Unit	8608	-	1	8644	-	1	8660	-	1
3	Flame Effect Motor	8609	-	2	8609	-	2	8609	-	2
4	Flame Screen	8610	-	1	8645	-	1	8661	-	1
5	Fuel Bed LED Lights	8611	RC07-137A	6	8611	RC07-137A	2	8611	RC07-137A	4
6	Spindle Of Fuel Bed	8612	-	1	8646	-	1	8662	-	1
7	Display Screen	8613	-	1	8647	-	1	8663	-	1
8	Front Glass Panel	8614	-	1	8648	-	1	8664	-	1
9	Fuel Bed	8615	-	1	8649	-	1	8665	-	1
10	Fuel Bed Front LED lights	8509	RC07-225A	4	8509	RC07-225A	4	8509	RC07-225A	4
11	Remote Control	8058	-	1	8058	-	1	8058	-	1
12	Fuel Bed LED Lights	-	-	-	-	-	-	8666	RC07-125A	4
13	Fuel Bed LED Lights	-	-	-	8650	RC07-169A	4	-	-	-
14	Power Cord UK	8480	-	1	8480	-	1	8480	-	1
	Power Cord EURO	8116	-	1	8116	-	1	8116	-	1
15	Flame Spindle	8625	-	1	8651	-	1	8667	-	1
16	Flame Effect LED Lights	8621	RC07-224B	1	8621	RC07-224B	1	8668	RC07-167F	1
17	Flame Effect LED Lights	8620	RC07-156B	1	8652	RC07-167E	1	8620	RC07-156B	2
18	Flame Effect LED Lights	8616	RC07-193C	1	8653	RC07-191C	1	8616	RC07-193C	1
19	Switch Control Panel	8617	-	1	8654	-	1	8654	-	1
20	PCB	8618	-	1	8618	-	1	8618	-	1
21	Power Board	-	-	-	8655	-	1	8655	-	1
22	Side Glass	8626	-	2	8626	-	2	8626	-	2
23	Side Panel	8619	-	2	8619	-	2	8619	-	2
24	Edging Strips 1	8639	-	2	8639	-	2	8639	-	2
25	Edging Strips 2	8640	-	2	8640	-	2	8640	-	2
26	Edging Strips 3	8641	-	2	8641	-	2	8641	-	2
	Black glass embers	8642	-	1	8658	-	1	8658	-	1
	Logs	8643	-	1	8659	-	1	8671	-	1

9. OTHERS

Environment



Meaning of crossed –out wheeled dustbin:

Electrical appliance should not be disposed as unsorted municipal waste. Separate collection facilities should be used in the disposal of electrical appliances. Contact your local government for the information about the available collection systems. If electrical appliances are disposed of in landfills or dumps, hazardous substances can leak into the groundwater and get into the food chain, damaging your health and well-being. When old appliances are replaced by the new ones, it is legal oblige for the retailer to take back the old appliance for disposals at least free of charge.



This fire complies with the Safety Standards EN 60335-1 and EN 60335-2-30 which covers the essential requirements of the Low Voltage Directive 2014/35/EU and the EMC standards EN 55014-1; EN 55014-2; EN 61000-3-2 and EN 61000-3-3 which covers the essential requirements of the European Electro Magnetic Compatibility 2014/30/EU, and the RED standards EN300220-2, EN 30148 9-1, EN30 1489 -3 and EN6 247 which covers the essential requirements of the European Radio Equipment Directive 2014/53/EU.

Control PCB	Remote Control Receiver	Remote Control Transmitter
Hardware: RC01-043B01 Software: V0	Hardware: RF290B V1.2	Frequency: ASK/OOK 433.92MHZ Maximum transmit power: 10mW Hardware: RF290A-TX-V1.3 Software: V2.4.1

Charlton & Jenrick Ltd

Unit D, Stafford Park 2, Telford, Shropshire, TF3 3AR

Tel: (0845) 5195 991 Fax: (0845) 5195 992

www.charltonandjenrick.co.uk